

TECHNICAL MANUAL

ORGANIZATIONAL MAINTENANCE MANUAL

**RADIO SETS AN/ARC-134, AN/ARC-134A,
and AN/ARC-134B**

This copy is a reprint which includes current
pages from Changes 1 through 3.

HEADQUARTERS, DEPARTMENT OF THE ARMY
AUGUST 1969

WARNING

DEATH or SERIOUS INJURY may result from hazards in this equipment unless proper safety measures are observed when maintaining the equipment. Electrical potentials up to 400 volts dc exist in Receiver-Transmitter RT-857/ARC-134 when the radio set is energized. Do not make contact with exposed wires or connectors when the equipment is energized. Set the PWR switch to OFF and open the circuit breaker(s) which supply operating power to the equipment before making any connections or disconnections.

DON'T TAKE CHANCES!

TECHNICAL MANUAL. }
 No. 11-5821-277-20 }

HEADQUARTERS
 DEPARTMENT OF THE ARMY
 WASHINGTON, D.C., 5 August 1969

**Organizational Maintenance Manual
 RADIO SETS AN/ARC-134, AN/ARC-134A, AND AN/ARC-134B**

	Paragraph	Page
CHAPTER 1. INTRODUCTION		
Section I. General		
Scope.....	1-1	1-1
Indexes of publications.	1-2	1-1
Maintenance forms and records	1-3	1-1
Reporting of equipment publication improvements	1-3.1	1-1
Destruction of material to prevent enemy use	1-3.2	1-1
Administrative storage	1-3.3	1-1
Use of term Hertz	1-4	1-1
II Description and data		
Purpose and use	1-5	1-2
Technical characteristics	1-6	1-3
Components and dimensions.	1-7	1-4
Nomenclature and common names	1-8	1-1
Description of equipment	1-9	1-4
Additional equipment required.	1-10	1-5
Difference in models	1-11	1-5
CHAPTER 2. INSTALLATION		
General	2-1	2-1
Sitting requirements	2-2	2-1
Packaging data	2-3	2-1
Unpacking instructions	2-4	2-1
Checking unpacked equipment	2-5	2-1
Interconnection	2-6	2-3
CHAPTER 3. OPERATION		
General	3 - 1	3-1
Principles of operation	3 - 2	3-2
Operating procedures.	3-3	3-2
Emergency operation	3-4	3-4
CHAPTER 4. ORGANIZATIONAL MAINTENANCE		
Section I. General		
Scope of maintenance,	4-1	4-1
Tools, test equipment, and materials required	4-2	4-1
II. Preventive maintenance procedures		
Preventive maintenance	4-3	4-1
Test procedure information	4-4	4-2
Test procedures	4-5	4-2
Intermediate preventive maintenance checks and services	4-6	4-4
Intermediate preventive maintenance checks and services chart	4-7	4-4
Periodic preventive maintenance checks and services	4-8	4-5

“This manual supersedes so much of TM 11-5821-277-25-1, 23 September 1986, Including changes, and so much of TM 11-5821-277-25-2, 7 July 1966, Including changes, as pertains to organizational maintenance.

	Paragraph	Page
Periodic preventive maintenance and services chart	4-9	4-6
Cleaning	4-10	4-7
Repainting and refinishing	4-11	4-7
Section III. Troubleshooting		
General	4-12	4-7
Troubleshooting chain	4-13	4-7
Section IV. Removal and replacement		
Control unit panel lump	4-14	4-9
Control unit control knobs	4-15	4-9
Control unit	4-16	4-10
Transceiver	4-17	
Resilient mount	4-18	
APPENDIX A. REFERENCES		A-1
B. MAINTENANCE ALLOCATION		B-1
Section I. Introduction		
II. Maintenance allocation chart		

RECEIVER TRANSMITTER
RY-857 ARC 134

MOUNTING
MOUNTING ARC 134 OR
MOUNTING ARC 134A

MOUNTING
HANDLE

CONNECTING PINS

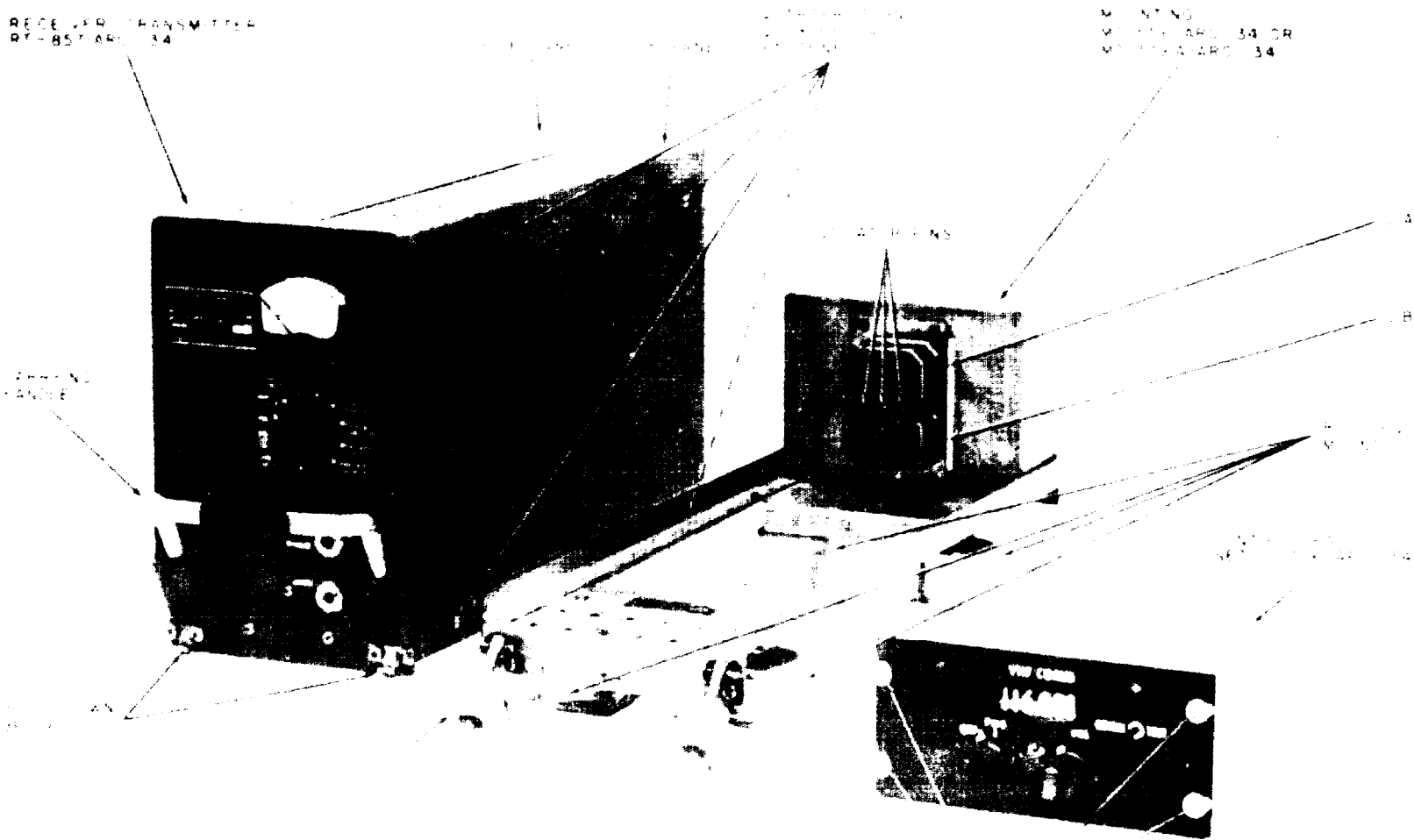

Figure 1-1. Radio Sets AN/ARC-134 and AN/ARC-134A.

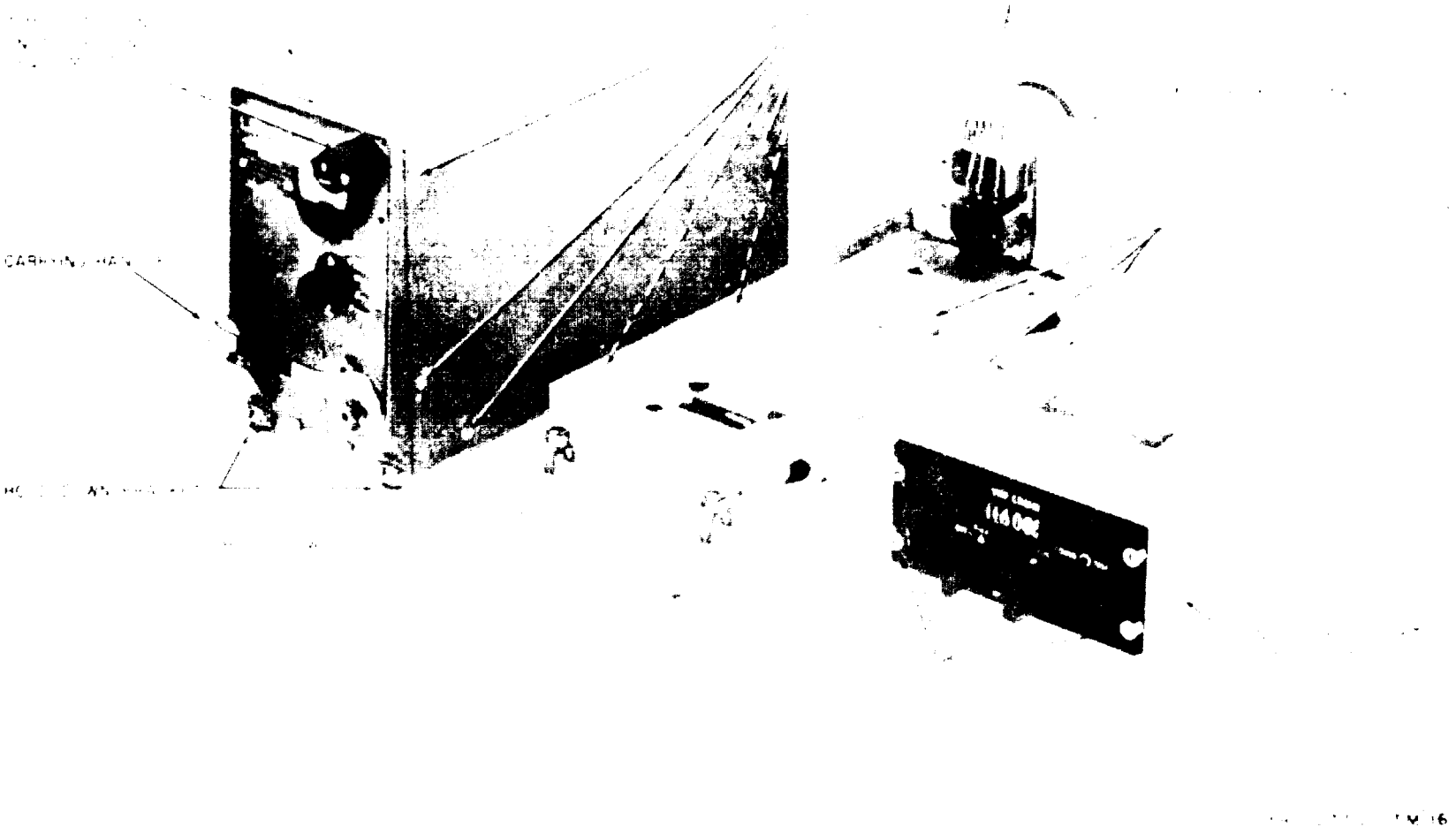

Figure 1-1. Radio Set AN/ARC-134B.

CHAPTER 1 INTRODUCTION

Section 1. GENERAL

1-1. scope

a. This manual describes Radio Set AN/ARC-134(A, B) (fig. 1-1) and includes instructions for installation and operation. The manual also covers organizational maintenance, troubleshooting, cleaning and inspection of the equipment, and replacement of parts available to the organizational maintenance repairman.

b. Nomenclature references in this manual followed by an (*) indicate that all models of equipment are specified, For example, Radio Set AN/ARC-134(*) represents Radio Set AN/ARC-134, AN/ARC-134A, and AN/ARC-134B, Mounting MT-3791(*)/ARC-134 represents Mounting MT-3791/ARC-134, MT-3791A/ARC-134, MT-3791B/ARC-134, and MT-3791OARC-134.

c. The maintenance allocation chart appears in appendix B.

1-2. Indexes of Publications

a. *DA Pam 310-4*. Refer to the latest issue of DA Pam 310-4 to determine whether there are new editions, changes or additional publications pertaining to the equipment.

b. *DA Pam 310-T*. Refer to DA Pam 310-7 to determine whether there are modification work orders (MWO'S) pertaining to the equipment .

1-3. Maintenance Forms and Records

a. *Reports of Maintenance and Unsatisfactory Equipment*. Maintenance forms, records, and reports which are to be used by maintenance personnel at all maintenance levels are listed in and prescribed by TM 38-750.

b. *Report of Packaging and Handling Deficiencies*. Fill out and forward DD Form 6 (Packaging

Improvement Report) as prescribed in AR 700-58/NAVSUPINST 4030.29/AFR 71-13/MCO P4030.29A, and DSAR 4145.8.

c. *Discrepant in Shipment Report (DISREP) (SF 361)*. Fill out and forward Discrepancy in Shipment Report (DISREP) (SF 361) as prescribed in AR 55-38/NAVSUPINST 4610.33/AFM 75-18/MCO P4610.19A, and DSAR 4500.15.

1-3.1 Reporting of Equipment Publication improvements

The reporting of errors, omissions, and recommendations for improving this manual by the individual user is encouraged. Report.. should be submittal on DA Form 2028 (Recommended Changes to Publications and Blank Forms) and forwarded direct to Commander, US Army Electronics Command, ATTN: AMSEL-MA-PSA Fort Monmouth, NJ 07703.

1-3.2 Destruction of Materiel to Prevent Enemy Use

For information on this subject, refer to TM 750-244-2

1-3.3 Administrative Storage

For procedures, forms and records, and inspection required during administrative storage of this equipment, refer to TM 740-91.

1-4. Use of Term Hertz

The National Bureau of Standards has officially adopted the term Hertz (Hz) to replace cycles per second (cps). This technical manual uses the term Hz in lieu of cps. The table below provides common equivalents.

Unit quantity	Old term	Old abbrev	New term	New abbrev
Frequency	Cycles per second	cps	Hertz	Hz
10 ³ cycles per second	Kilocycles per second	kc	Kilohertz	kHz
10 ⁶ cycles per second	Megacycles per second	mc	Megohertz	MHz
10 ⁹ cycles per second	Gigacycles per second	gc	Gigohertz	GHz

Section II. DESCRIPTION AND DATA

1-5. Purpose and Use

a. *Purpose*, Radio Set AN/ARC-134(*) operates in the very high frequency (vhf) range, 116.000 through 149.975 MHz, and uses amplitude modulation (am.) to provide receive and transmit voice communications between aircraft, and between aircraft and fixed or mobile ground radio stations. Radio Set AN/ARC-134 (*) has the design capability to be tuned to any one of 1,360 channels spaced at 25-kHz intervals throughout its operating frequency range; however, filters supplied with the AN/ARC-134(*) limit channel spacing to 50 kHz and permit the AN/ARC-134(*) to be tuned to only 680 selectable channels. Alternate filters can be installed which provide a bandpass of 20 kHz for 25-kHz channel spacing, providing the 1,360 channel tuning capability. When used with auxiliary equipment, Radio Set AN/ARC-134(*) receives and transmits communication signals for an Air Traffic Control Signaling System (ATCSS).

b. *Use*. Radio Set AN/ARC-134(*) is normally installed in an aircraft and used by crewmembers to establish voice communication with crewmembers of other aircraft and personnel in fixed or mobile ground radio stations. Mounting MT-3791(*)/ARC-134 and Receiver-Transmitter RT-857/ARC-134 are located in the elec-

tronics bay of the aircraft. Control, Radio Set C-7197/ARC-134 is on the pilot's or copilot's instrument panel to facilitate tuning by the desired frequency. Figure 1-2 is a typical block diagram of Radio Set AN/ARC-134(*) installed in an aircraft. Additional equipment (para-10) is necessary to permit Radio Set AN/ARC-134(*) to perform its desired function. A vhf antenna must be provided on the aircraft to permit reception and transmission. Headset H101A/U, or equivalent, must be available to provide the operator monitoring capability for audio signals received by Receiver-Transmitter RT-857/ARC 134. The headset is normally wired through aircraft wiring to Control, **Intercommunication Set C-1611(D)/AIC**, or equivalent. External push-to-talk switching is also wired through aircraft wiring to the C-1611D/AIC which is wired to Receiver-Transmitter RT-857/ARC-134. When the operator presses the push-to-talk switch and speaks into the microphone, the transmit function of Receiver-Transmitter RT-857/ARG 134 is enabled and the desired signal is transmitted. When the push-to-talk switch is not pressed, Receiver-Transmitter RT-857/ARC-194 is in the receive mode. Detected audio signals are routed through the C-1611D/AIC to the operator's headset.

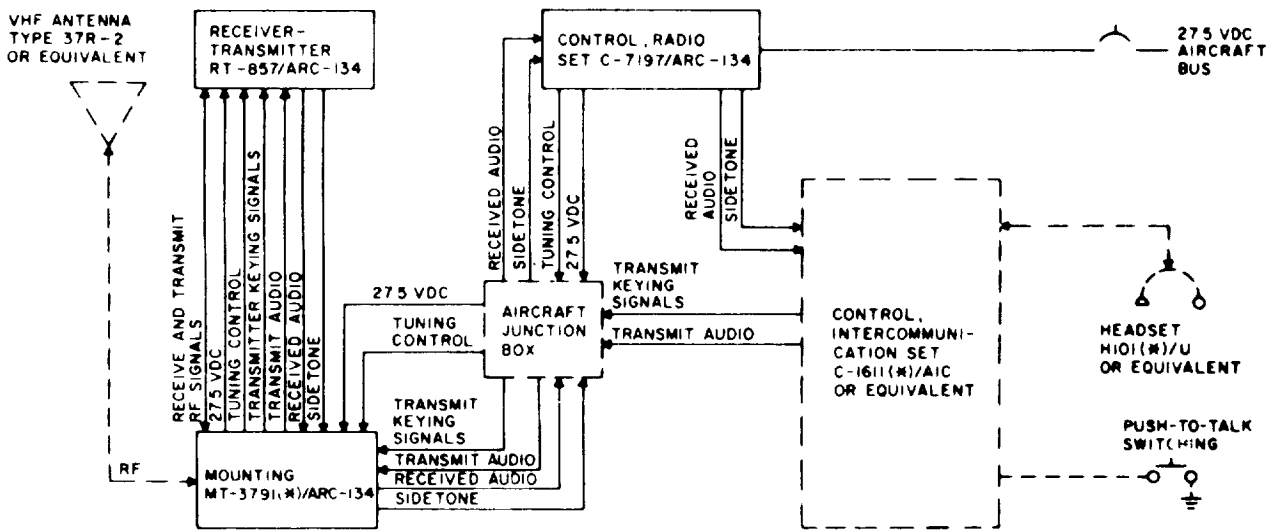

NOTE
DASH LINES INDICATE EQUIPMENT NOT SUPPLIED AS PART OF RADIO SET AN/ARC-134(*) BUT REQUIRED FOR OPERATION WHEN INSTALLED IN AN AIRCRAFT

EL5021-277-20-6

Figure 1-2. Typical operational block diagram.

1-6. Technical Characteristics

a. Overall.

Power Input ----- +27.5 volts dc, -20 to +10 percent, 11 amperes maximum.

Power consumption:

Receive ----- 2.0 amperes
 Transmit ----- 7.5 amperes, carrier only.
 10.5 amperes, carrier with 100-percent modulation

Frequency range ----- 116.000 through 149.975 MHz..

Number Of channel ---680 channels, as supplied, spaced 50-kHz apart for receive and transmit. Alternate filters may be installed for 25-KHz channel spacing, providing 1,360 channels.

Channeling time ----- Less than 4 seconds.

Frequency selection---Two out of five (2 X 5) system.

Environmental requirements:

Temperature :

Continuous Operation --- -54°C to +55°C (-65°F to +181° F).

Intermittent operation --- -54°C to +71°C (-65°F to +160°F).

(30 minutes maximum) .

Power removed ---- -62°C +71°C (-79.6°F to +160°F).

Humidity -----95 to 100 percent at 50°C (112°F) for 48 hours with moisture condensation on equipment removed once each hour.

Altitude ----- 45,000 feet maximum

Vibration:

Shockmounted -----0.30-inch constant excursion from 10 to 55 vibrations per second with maximum acceleration of 5 g. Constant acceleration of 5 g from 55 to 500 vibrations per second.

Rigid mount ----- 0.020-inch constant excursion from 5 to 37 vibrations per second with maximum acceleration of 8 g. Constant acceleration of 1.5 g from 37 to 500 vibrations per second.

Shock ----- 6 g operating; 15 g impact (10-millisecond duration).

b. Receiver-Transmitter RT-857/ARC-134 (Receive Function) .

Input impedance ----- 52 ohms, coaxial.

Sensitivity -----A maximum signal of 8 microvolts, modulated 30 percent at 1,000 Hz is required to achieve 6-db signal plus noise-to-noise ratio.

Selectivity:

Normal (using supplied 50-kHz filters, FSN 5915-989-0898 and FSN 5915-731-8211, in positions FL106 and F1301) ±15 kHz wide minimum at 6 db down; +31.5 kHz wide maximum at 60 db down.

Sharp (using optional 2.5-kHz filters Wilcox, puts No. 44266-2 and 98179-2, in positions FL106 and FL301) ±6 kHz wide minimum at 6 db down, ±18 vdc wide maximum at 60 db down.

All spurious responses----- At least 60 db down.

Audio output impedance:

Receiver ----- 500 ohms nominal; accommodates output loads from 200 ohms to infinity.

ATCSS ----- 100 ohms.

Audio distortion ----- Less than 7.5 percent at normal rated output for signal modulated 30 percent at 1,000 Hz.

Audio response ----- Less than 6-db total variation from 300 to 3,750 Hz.

Agc ----- Receiver output will not vary more than 3 db over range of signal input levels from 5 to 100,000 microvolts, and not more than 6 db over range of signal input levels from 6 to 500,000 microvolts. Receiver will not overload with 1-volt input signal.

Squelch threshold -----3 microvolts or less, internally adjustable.

c. Receiver-Transmitter RT-857/ARC-134 (Transmit Function).

Output impedance ----- 52 ohms, coaxial.

Power output ----- 25 watts minimum; 40 watts nominal

Frequency stability ----- Better than 0.005 percent-

Type of emission ----- Carrier plus modulation.

Type of modulation ----- Amplitude, high level.

Modulation system ----- Internal modulator capable of modulating transmitter 100 per cent with a voltage of 0.35 volt rms at 1,000 Hz applied to 100 ohm input circuit. Overall distortion will not exceed 10 percent at 100 percent at 100-percent modulation at 1,000 Hz. Audio system flat within 6 db from 300 to 3,000 Hz.

Audio input impedance:	
Microphone	100 ohms
ATCSS	100 ohms
0 dbm	500 ohms, center-tapped.
Audio input	
Microphone	0.25 volt, 1,000 Hz.
ATCSS	1.0 volt, 1,000 Hz.
0 dbm	1 milliwatt, 1,000 Hz.
Sidetone output impedance	500 ohms nominal; accommodates output loads from 200 ohms to infinity.
Sidetone output	100 milliwatts into external 200- or 500-ohm resistive load for 100-percent modulation.

d. Control, Radio Set C-7197/ARC-134.

Power requirements	27 volts dc.
Frequency range and channel spacing	116.00 through 149.975 MHz, 25-kHz channel spacing.
Frequency selection method	Two out of five (2 x 5) system.
Ambient temperature:	
Continuous operation	-54 C to +55 C (-65 F to +131 F).
Intermittent operation	-54 C to +71 C (-65 F to +160 F).
(30 minutes, maximum).	
Power removed	-62 C to +71 C (-79 F to +160 F).
Humidity	95 to 100 percent at 50 C (+122 F) for 58 hours with moisture condensation on equipment removed once each hour.
Altitude	45,000 feet maximum.
Vibration	0.020-inch constant excursion from 5 to 37 vibrations per second with maximum acceleration of 1.5 g from 37 to 500 vibrations per second.
Shock	6 g operating; 15 g impact (10-millisecond duration).

1-7. Components and Dimensions

Item No.	Dimensions (in.)			Unit Weight (lb.)	Equip. No.
	Height	Depth	Width		
Control radio Set C-7197/ARC-134.	2.625	6.00	4.75	2.1	1-1
Mounting MT-3791 (*)/ARC-134.	5.31	16.78	5.25	1.6	1-1
Receiver-Transmitter RT-857/ARC-134.	7.75	14.56	5.00	15.9	1-1

1-8. Nomenclature and Common Names

A list of the nomenclature assignments for Radio Set AN ARC-134(*) is provided below. A common name used throughout this manual is indicated after each item.

Nomenclature	Common Name
Radio Set AN ARC-134(*)	Radio Set
Mounting MT-3791(*)/ARC-134	Mounting
Control, Radio Set C-7197/ARC-134	Control unit
Receiver-Transmitter RT-857/ARC-134	Transceiver

1-9. Description of Equipment

a. General. The lightweight, solid-state radio set (fig. 1-1) which is mounted in an aircraft, consists of a transceiver, a mounting, and a control unit. The transceiver slides into the mounting. A dual electrical connector at the rear of the transceiver mates with a dual connector at the rear bracket of the mounting. Aircraft cabling is hard-wired to feed-through pins at the rear of the mounting to provide interconnection necessary for operation of the radio set. Additional information on the individual components of the radio set is provided in *b*, and *d* below.

b. Transceiver (fig. 1-1). The aluminum transceiver includes five basic sections: front panel, bottom deck, receiver chassis, center chassis, and rear panel. Two side covers completely enclose the equipment. The covers are released by turning the quick-release fasteners at each corner of the covers, one-quarter turn. The receiver chassis extends along the left side of the equipment; it is attached to the rear panel by hinges, and to the front cover and center chassis by quick-release fasteners. When the left side cover is removed and the quick-release fasteners are disengaged, the receiver chassis swings out from the side of the unit to provide access to the rear of the receiver chassis and the left side of the center chassis (fig. 1-3). A monitor meter, a meter select switch, a PHONE jack, a MIKE jack, a standard carrying handle, and two holddown brackets are on the front panel. The rear panel (fig. 1-4) is a heat sink which mounts three transistors and a dual electrical connector. The connectors mate with the connectors on the mounting when the transceiver is installed in the mounting (fig. 1-5), and provide all interconnections necessary for operation of the transceiver.

c. Control unit (fig. 1-1). The control unit consists of a chassis and a front panel. The chassis is enclosed in an aluminum housing. The

front panel is also aluminum but is equipped with an edge-lighted, black plastic overlay so that only panel markings are lighted by three panel lights. Two internal lamps light the tuning window when power is applied to the radio set. Quick-release fasteners are at each of the four corners of the front panel to secure the control unit to an aircraft instrument panel, or to another suitable mounting if desired. A VHF COMM tuning indicator window, two tuning knobs, a VOL control (concentric with the right-hand tuning knob), an OFF PWR switch (concentric with the left-hand tuning knob), a COMM TEST pushbutton switch, and three panel lamps are mounted on the front panel of the control unit. Connector J1 at the rear of the chassis (fig. 1-7) provides all necessary interconnections for the control unit.

d. *Mounting* (fig. 1-1). The aluminum mounting consists of two guide channels and a rear bracket. Four resilient mounts are affixed to the bottom of the guide channels. The resilient mounts secure the mounting to the aircraft and protect the transceiver from vibration and shock.

Two holddown clamps are on the mounting. When the transceiver is installed in the mounting (fig. 1-6), the holddown clamps slip over the holddown brackets on the transceiver and secure the transceiver in place. Dual connector J1A and J1B on the mounting mates with dual connector J1A and J1B at the rear of the transceiver (fig. 1-5). Feedthrough pins at the rear of the mounting (fig. 1-7) are provided for connection of aircraft wiring necessary for integration of the radio set into the aircraft avionics system.

1-10. Additional Equipment Required

Table 1-1 lists the additional equipment required for operation of the radio set.

NOTE

The equipment listed in the table below includes additional equipment required for operation of the radio set when it is installed in an aircraft and using the C-16LID/AIC in the aircraft. To provide transmit and receive capability at the front panel of the *transceiver*, use *Microphone M-52B/U* and *Headset, Electrical H-216/U*.

Table 1-1. Additional Equipment

Equipment	Purpose	Applicable publication
Vhf antenna (type 37R-2 or equivalent).	Receives and transmits RF energy.	
Control, Intercommunication Set G1611(D)/AIC, or equivalent.	Interfaces received audio signals into aircraft audio distribution system, routes audio signals from microphone to <i>modulator section of transceiver</i> , and switches transceiver <i>from receive to transmit</i> function.	TM 11-5831-201-35
Headset H101A/U, or equivalent.	Provides aural monitoring capability for received audio signals. Also provides microphone for routing of voice signals to transmitter portion of transceiver through Control, Intercommunication Set C-1611(D)/AIC.	TM 11-5965-216-15
External push-to-talk switch circuitry.	Enables operation of microphone amplifier in C-1611(D)/AIC, and applies transmit keying signal to transceiver through C-1611(D)/AIC.	Applicable aircraft technical manual.
Aircraft junction box	Provides interface for radio set and aircraft wiring.	Applicable aircraft technical manual.
Aircraft cabling	Provides necessary interconnection of radio set in aircraft.	Applicable aircraft technical manual.

1-11. Difference in Models

Radio Sets AN/ARC-134 and AN/ARC-134A are modified to Radio Set AN/ARC-134B as a result of MWO 11-5821-277-30/1.

MWO 11-5821-277-30/1 is a depot modification to Receiver-Transmitter RT-857/ARC-134 and to Mounting MT-3791/ARC-134 and MT-3791/ARC-134 which results in Mounting MT-379/ARC-134.

Mounting MT-3791/ARC-134 may be used in place of MT-3791B/ARC-134, The only apparent difference is that MT-3791 C/ARC-134 has four ground straps. Specific differences are given in table 1-2.

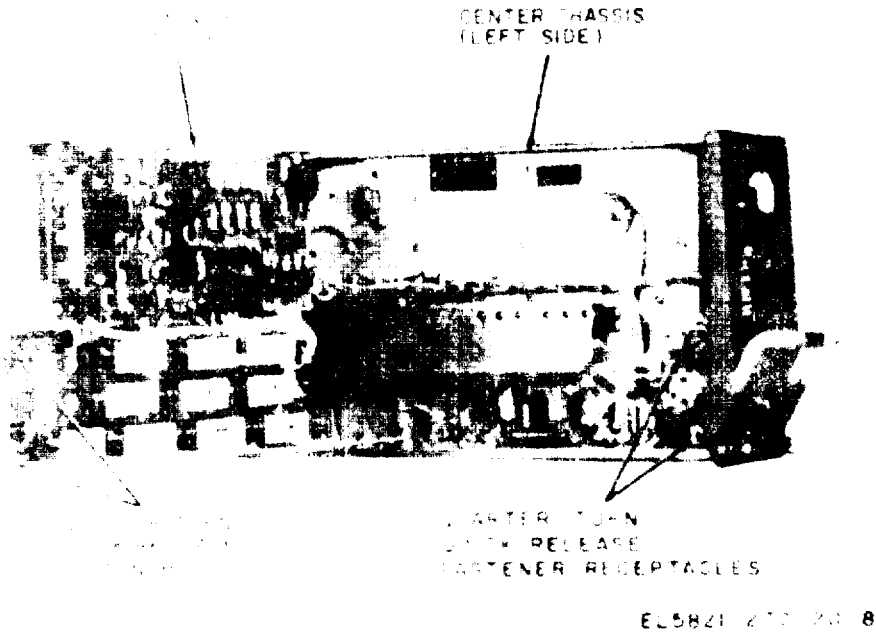

Figure 1-3. Unmodified Receive Transmitter RT-857/ARC-134, left-side cover removed and receiver chassis swung open, side view.

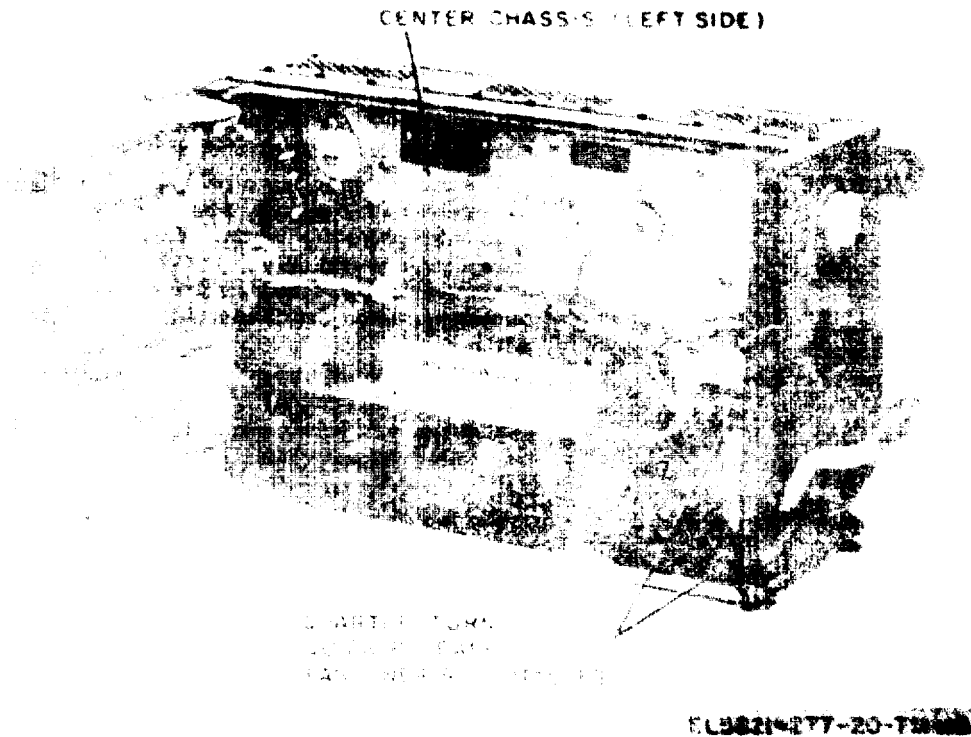

Figure 1-3.1. Receiver-Transmitter RT-857/ARC-134 (modified by MWO 11-5821-277-50/1), left-side cover removed and receiver chassis swung open, side view.

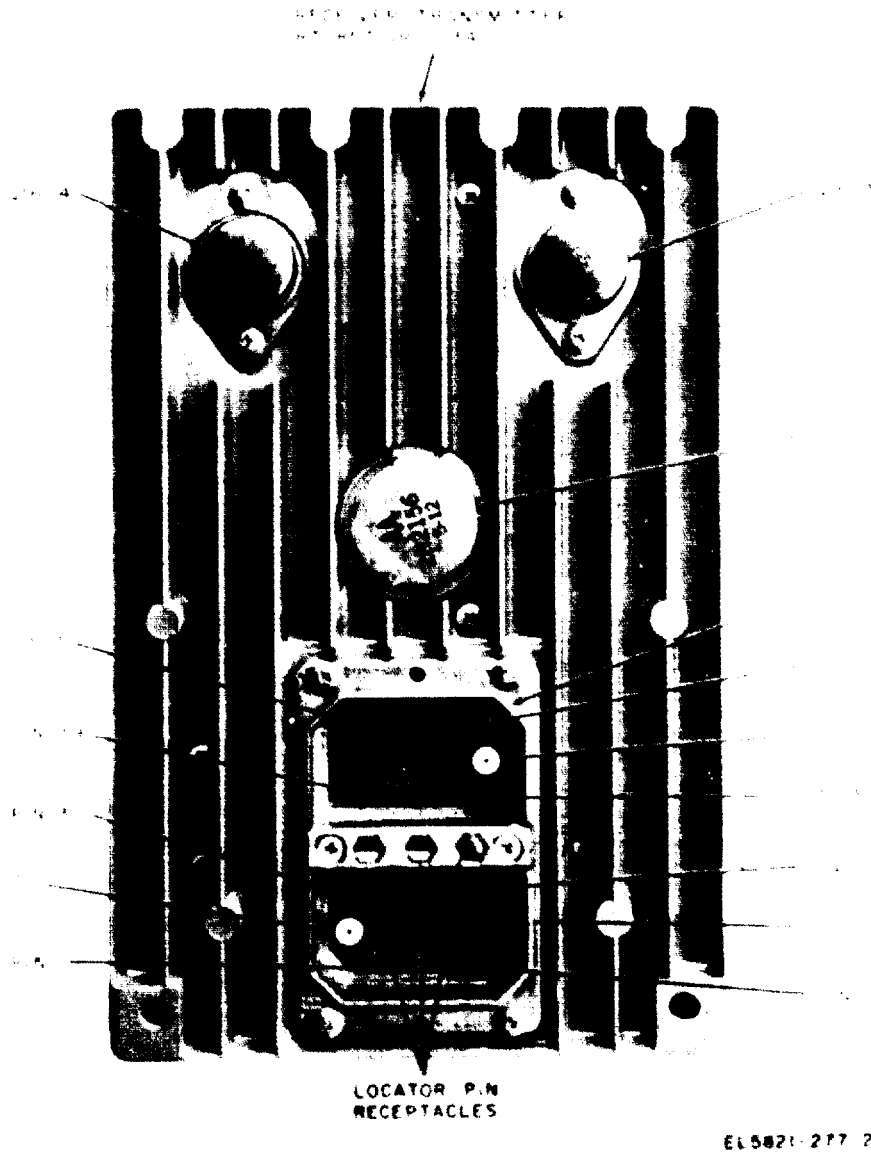

Figure 1-4. Receiver-Transmitter RT-857/ARC-134, rear view.

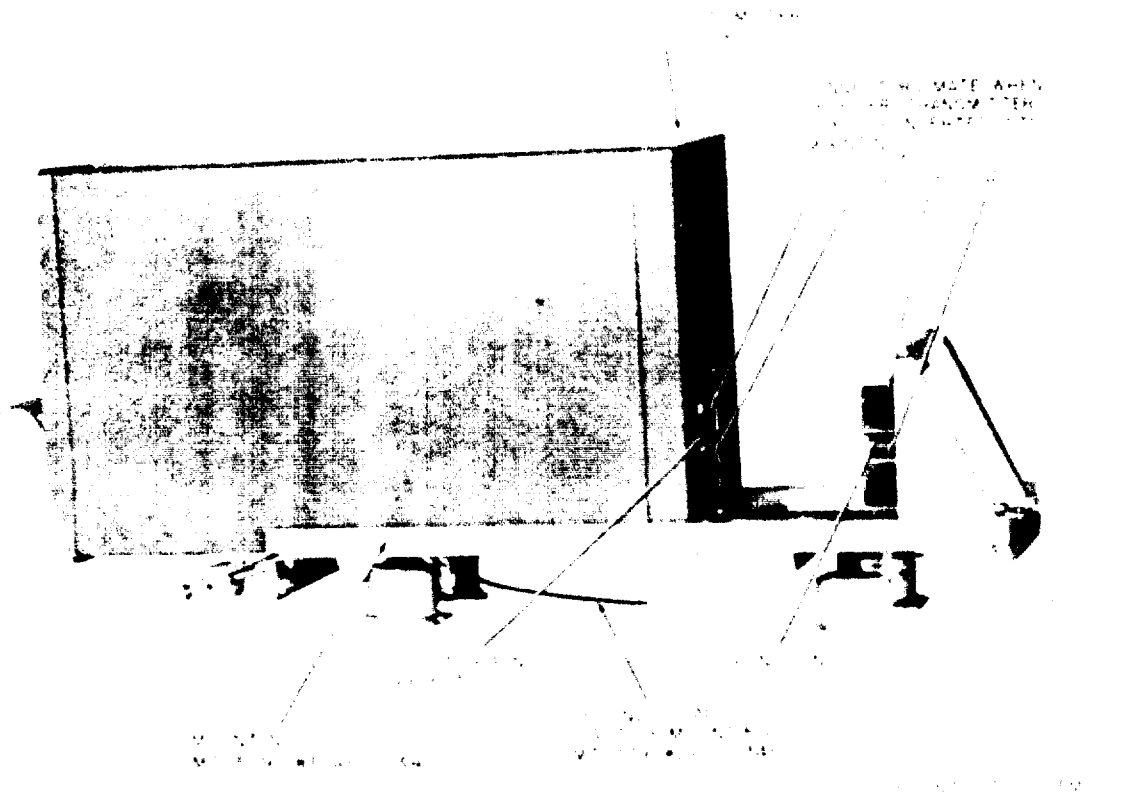

Figure 1-5. Receiver-Transmitter RT-857/ARC-134, partially installed in MT-3791/ARC-134 showing mating connectors.

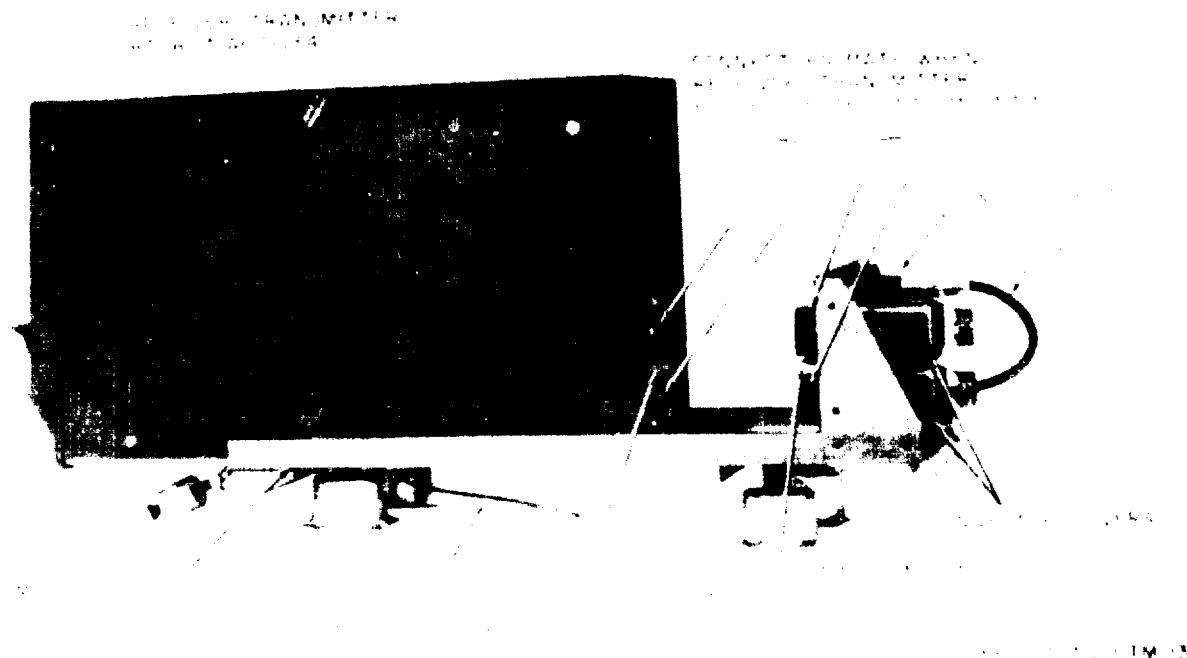

Figure 1-5.1 Receiver-Transmitter RT-857/ARC-134, partially installed in Mounting MT-3791B/ARC-134, allowing mating connection.

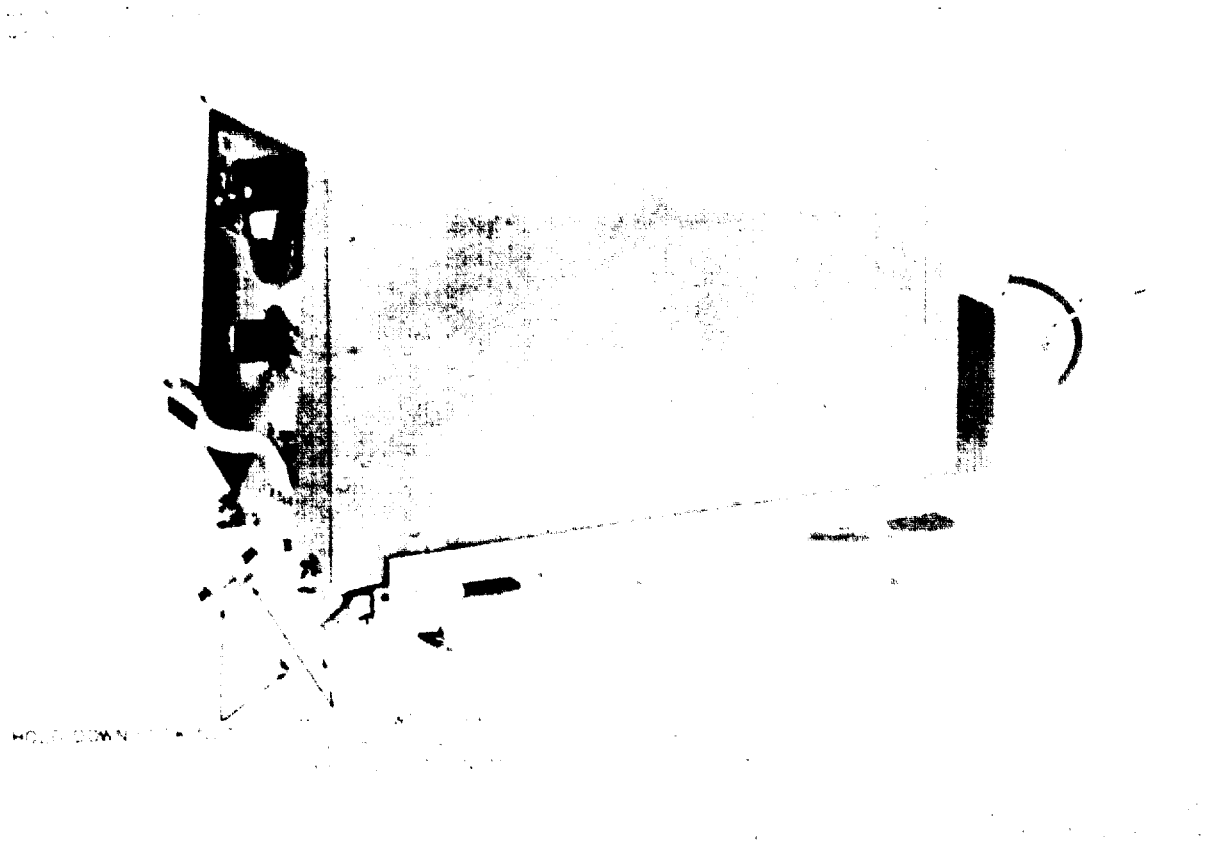
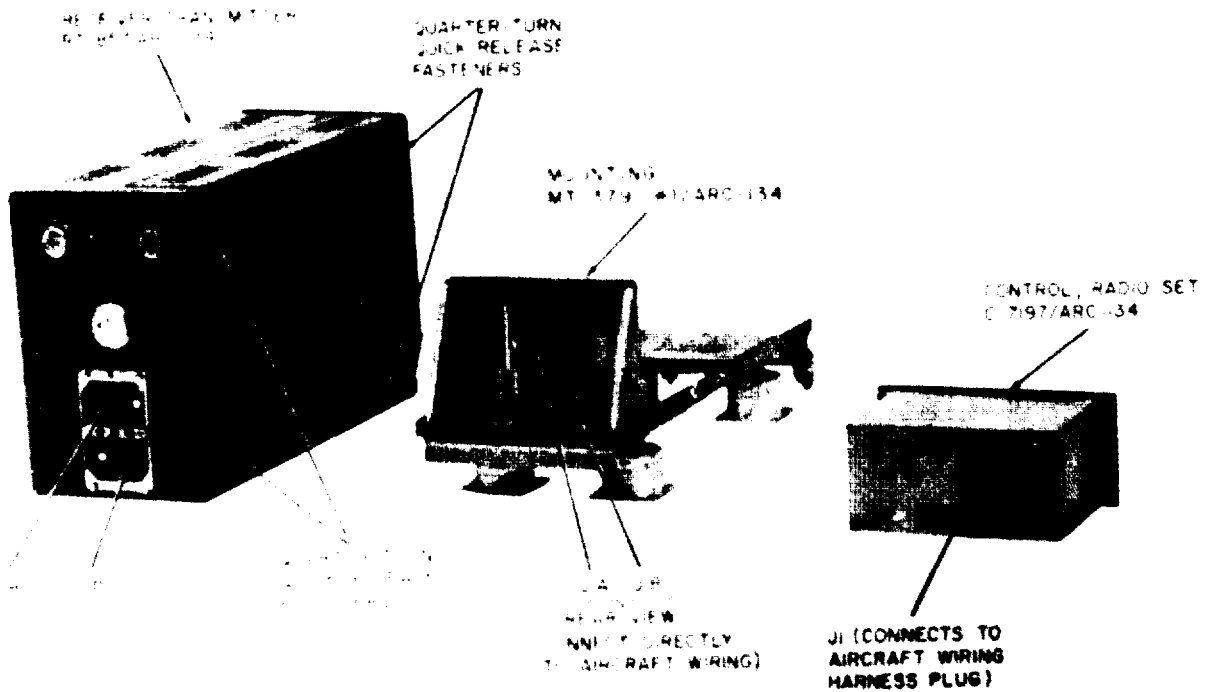
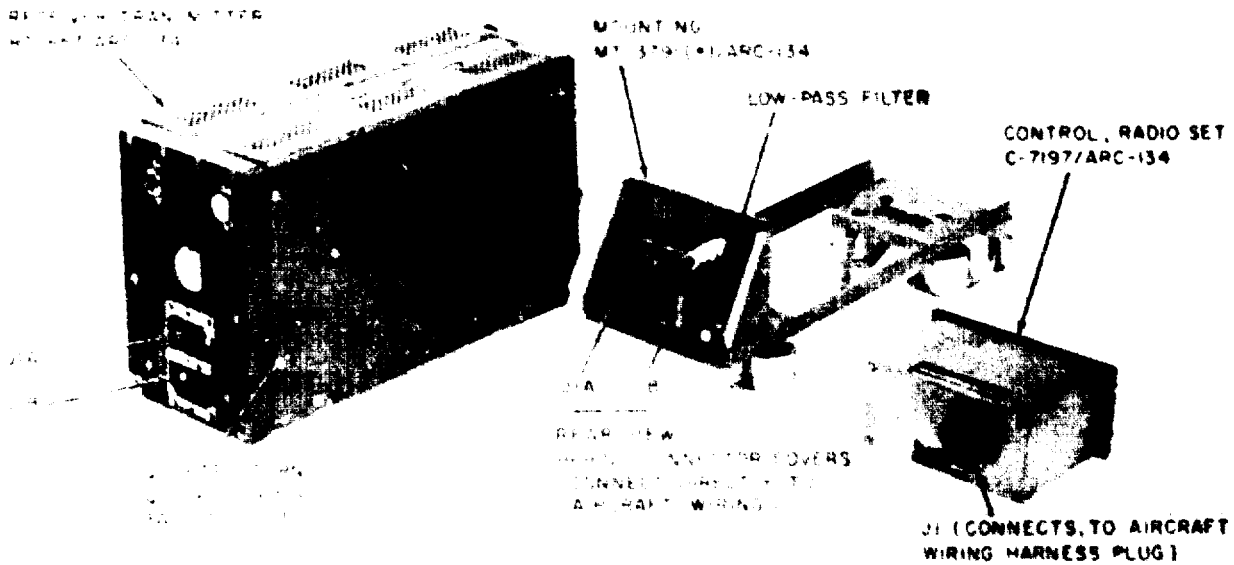

Figure 1-6. Receiver-Transmitter RT-857/ARC-134 installed in Mounting MT-3791(*)/ARC-134.



EL5821-277-20-2

Figure 1-7. Radio Sets AN/ARC-134 and AN/ARC-134A, rear view of component



EL5821-277-20-TM-145

Figure 1-7.1. Radio Set AN/ARC-134B, rear view of components.

CHAPTER 2 INSTALLATION

2-1. General

Since the radio set is normally installed in an aircraft by the manufacturer of the aircraft, or during a retrofit program, limited installation information is provided in this chapter.

2-2 Siting Requirements

The control unit is normally mounted in the cockpit of the aircraft. The minimum space requirements for the control unit are shown in A, figure 2-1. The mounting is normally installed in the electronics bay of the aircraft and the transceiver installed in the mounting (fig. 1-6). The minimum space requirements for the transceiver are shown in B, figure 2-1. The minimum space requirements for the mounting (including the mounting hole arrangement) are shown in C, figure 2-1. These illustrations are finished primarily for planning purposes only. Sufficient space is required at the rear of the control unit for the aircraft wiring harness and the associated plug which mates with J1 at the rear of the equipment. Also, adequate space must be provided to perform operating procedures and for removing the control unit from its mounting when necessary. When planning installation of the mounting, consideration should be given to provisions for adequate space for making connections to aircraft wiring at the rear of the unit, and for removing the transceiver from the front of the mounting.

2-3. Packaging Data

(fig. 2-2)

The three components of the radio set are shipped in a cardboard container, 18 by 16 by 16 inches, with a volume of 2.08 cubic feet. The shipping weight is approximately 30 pounds. Each of the three components is placed in individual cardboard cartons. The control unit is placed in a plastic bag before

packaging and the transceiver is enclosed in a double cardboard carton. The three individual cartons are then placed in a cardboard box which is thoroughly sealed with paper tape. The box is then sealed inside a moistureproof barrier which, in turn, is placed in an outer fiberboard box sealed with canvas tape. The radio set is shipped with all pluckout items installed.

2-4. Unpacking Instructions

CAUTION

Do not use a heavy instrument, such as a crowbar, to pry or dig during unpacking. Be extremely careful to avoid damage to finish or components.

Be careful while unpacking to avoid rough handling that can damage the equipment or disturb the adjustments. Follow the procedures listed below to avoid damage.

- a. Maintain the carton in an upright position.
- b. Carefully cut the tape that seals the outer carton.
- c. Cut the moistureproof barrier and tear it open.
- d. Carefully cut the tape that seals the inner box.
- e. Remove the individual cartons one at a time.
- f. Carefully open each carton and remove the radio set components.

2-5. Checking Unpacked Equipment

- a. Inspect the equipment for damage that may have occurred during shipment. If the equipment has been damaged, fill out and forward DD Form 6 (para 1-3b).
- b. Check to see that the equipment is complete as listed on the packing slip. Report all discrepancies in accordance with TM 38-750. The equipment should be placed in service even though a minor assembly or part, that does not affect proper functioning, is missing.

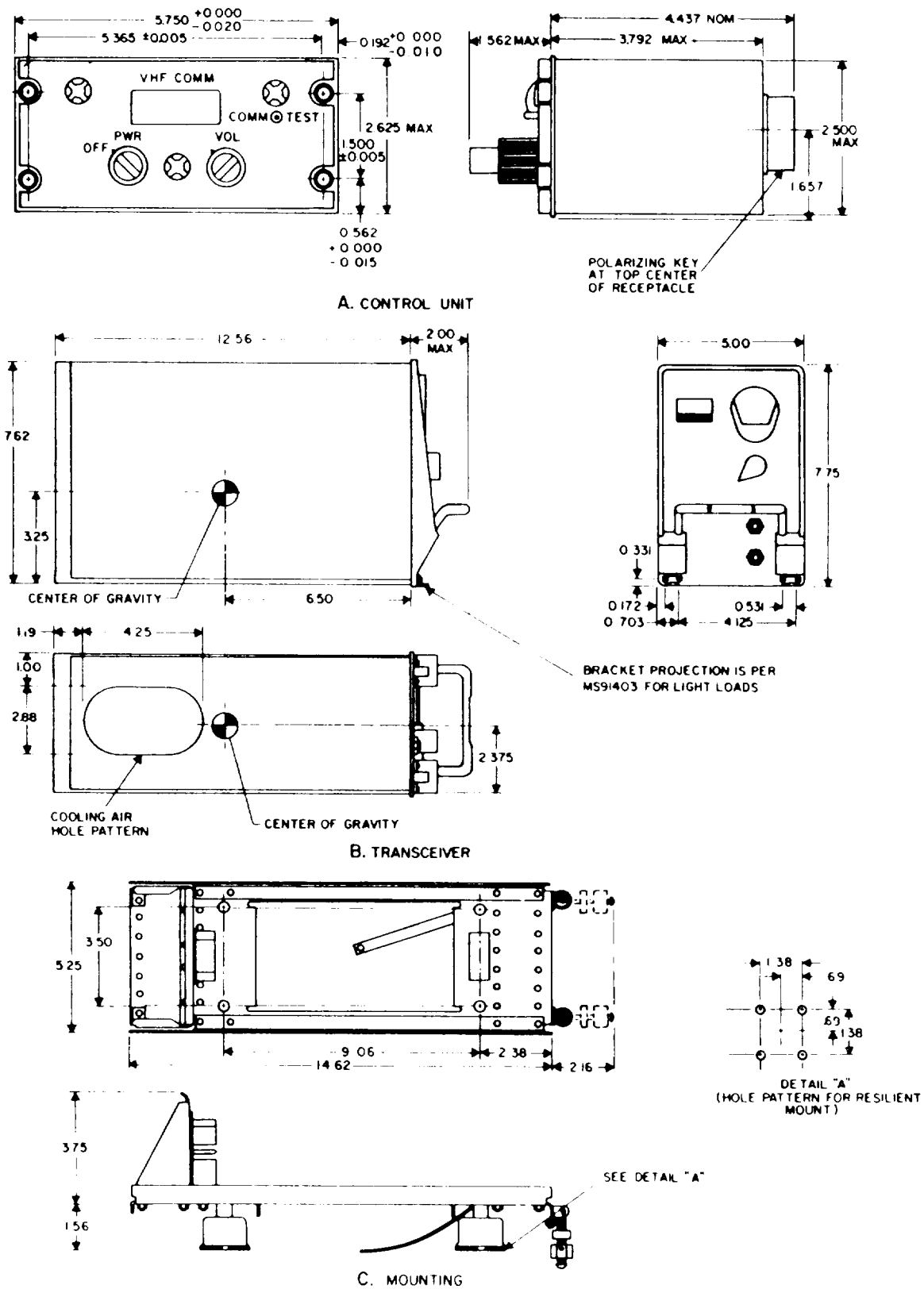

EL5821 277-20-5

Figure 2-1. Radio set outline dimensional drawing.

c. Check to see whether the equipment has been modified. If the equipment has been modified, the MWO number will appear on the front panel, near the nonmenclature plate. Check also to see whether all MWO's current at the time the equipment is placed in use have been applied.

NOTE

Current MWO's applicable to the equipment are listed in DA Pam 310-7.

2-6. Interconnection

Interconnections necessary for radio set operation are shown on figure 2-3; however, actual aircraft cabling necessary to effect the interconnections is not shown since such cabling will vary between installations. Transceiver sensitivity, squelch, and automatic gain control threshold should be checked by higher category personnel before installation. The performance check outlined in paragraph 4-5 should be performed subsequent to installation to insure that the radio set is operational.

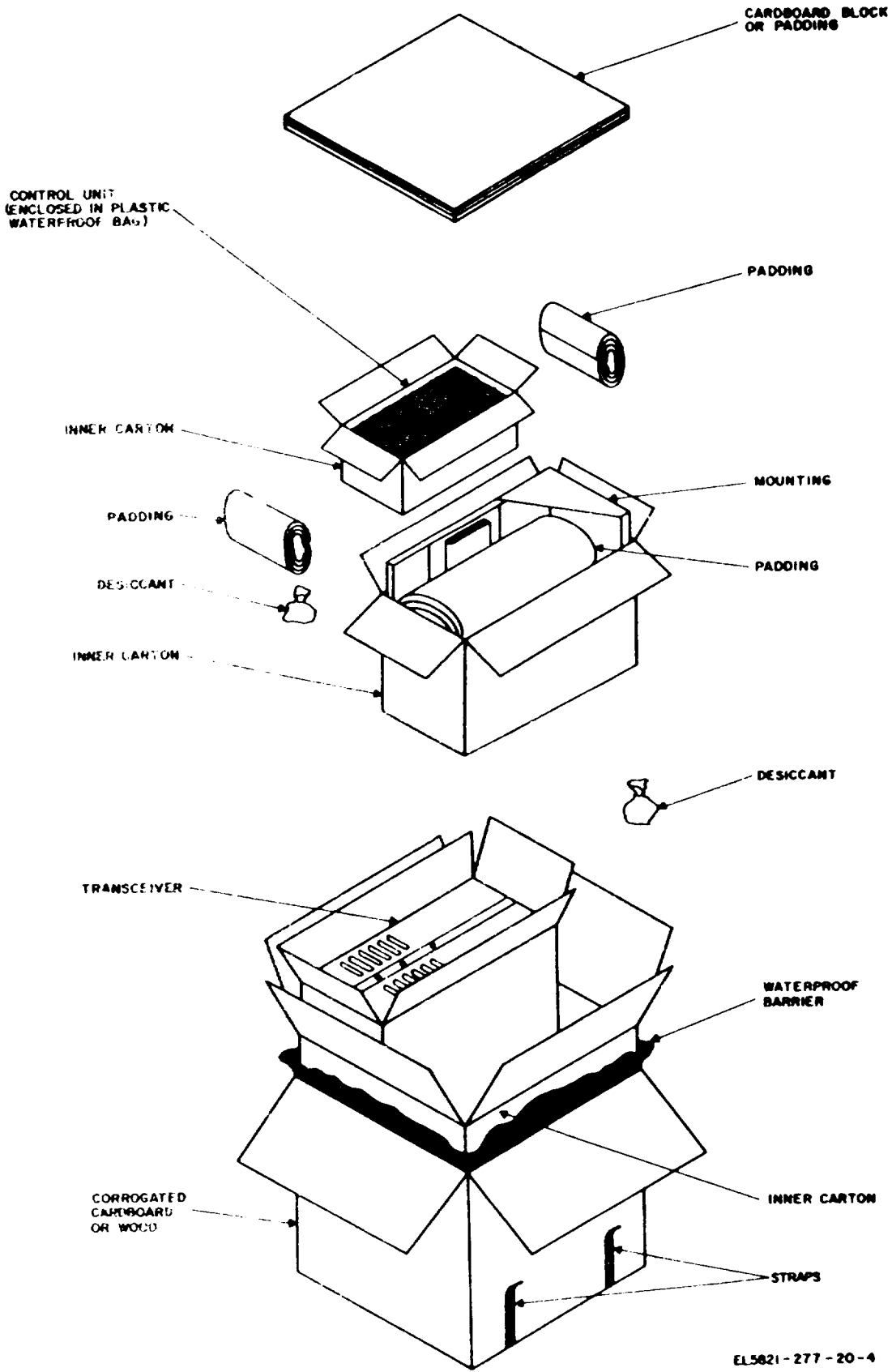

EL5821-277-20-4

Figure 2-2. Packaging details.

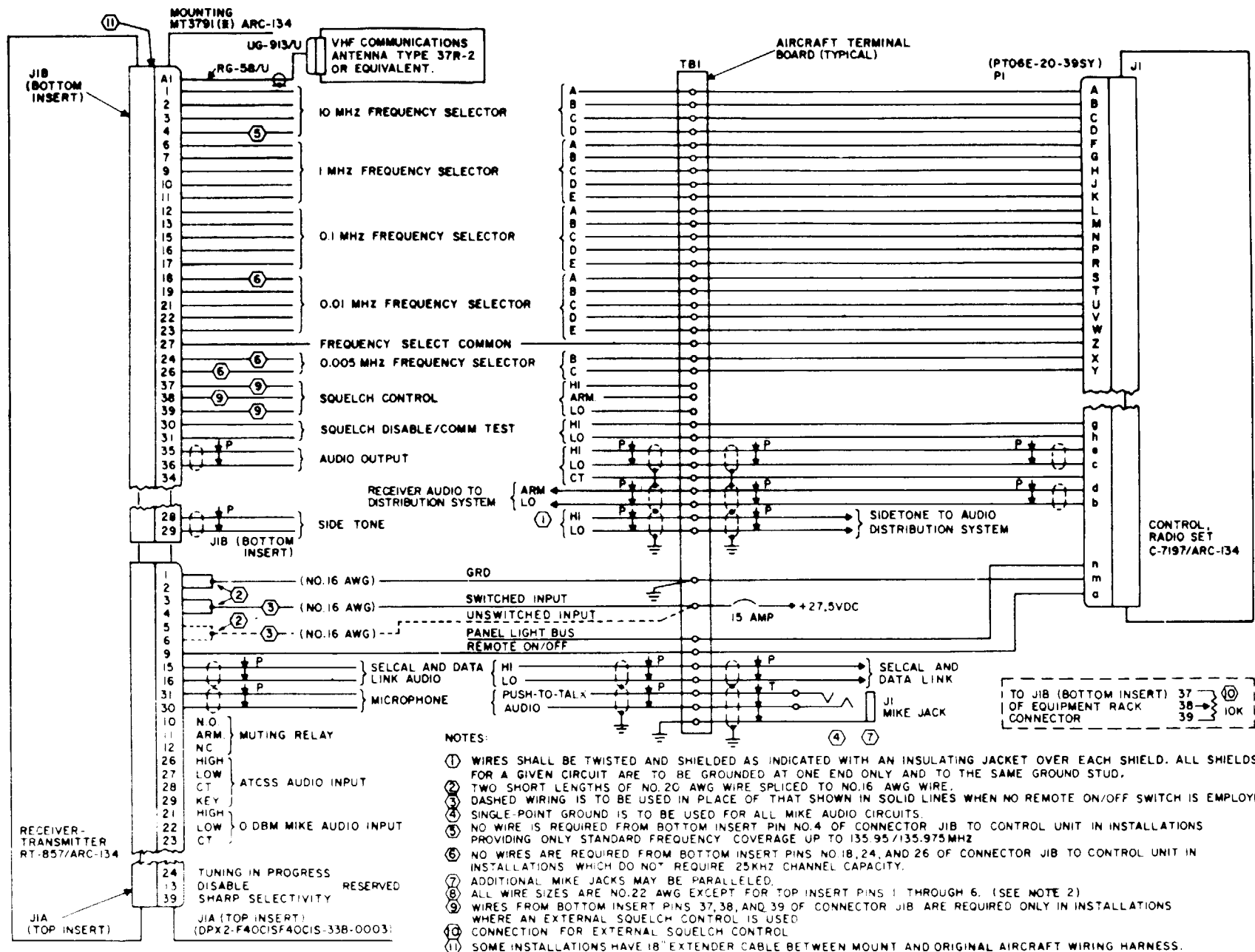

Figure 2-3. Typical radio set interconnections.

CHAPTER 3
OPERATION

3-1. General

Except for certain controls unique to the aircraft, all controls necessary for operation of the radio set are on the front panel of the control unit. The control unit is normally located in the

cockpit in a position where it is convenient to both the pilot and the copilot. A switch, meter, and two jacks (primarily for use by maintenance personnel) are on the front panel of the transceiver. The operating controls and their functions are described in a and b below.

a. Control Unit (fig. 3-1).

Control or indicator	Function
OFF-PWR switch (concentric with MHz turning control).	Applies power to radio set when set to PWR.
VOL control (concentric with kHz tuning control) -----	Adjusts volume of audio output from transceiver.
MHz tuning control (left side) -----	Controls selection of operational frequency in 1.0-MHz steps (second and third digits, left to right, in VHF COMM indicator).
kHz tuning control (right side) -----	Controls selection of operational frequency in 25-kHz steps (last three digits, left to right, in VHF COMM indicator).
VHF COMM frequency indicator -----	Indicates operational frequency in MHzs to which transceiver is tuned.
COMM TEST pushbutton switch -----	When pressed, switch disables squelch circuit.
Panel lights (3) -----	Illumination of controls.

b. Transceiver (fig. 9-2).

Control indicator or jack	Function
•Time totalizing meter	Monitors total time transceiver is in operation.
Monitor meter -----	Monitors output of circuits selected by meter selector switch.
Meter selector switch (11-position) -----	When set to positions listed below, the circuit indicated is connected to monitor meter which, in turn, furnishes a visual indication of circuit output.

Switch position	Circuit connected to monitor meter
OFF -----	Open input circuit to monitor meter.
LINE V 100 V FS.	Transceiver primary power input to input of transient suppressor circuit (Meter calibrated to read 100 volts fullscale)
REG SUP 100 V FS.	Output of 20-volt dc regulator circuit (meter calibrated to read 100 volts full-scale.)
AGC -----	Connection of 20-volt dc source and age bus. (Meter uncalibrated, furnishes indication of age action.)

† Not used on all units,

Switch position	Function	Circuit connected to monitor meter
MOD 1 10 A FS.		Emitter current of shunt resistor and modulator circuit. (Meter calibrated to read 10 amperes full-scale.)
DRIVER V 100 V FS. ----		Driver/amplifier collector voltage through a series multiplying resistor. (Meter calibrated to read 100 volts full-scale)
DRIVER 1 1 A FS.		Driver/amplifier collector and shunt resistor circuit current. (Meter calibrated to read 1 ampere full-scale.)
PA GRID 1 100 MA FS.		Power amplifier and shunt resistor circuit grid current (Meter calibrated to read 100 milliamperes full-scale.)
PA B+ 1000 V FS.		Transmitter power supply and rester multiplier junction circuit 400-volt output. (Meter calibrated to read 1,000 volts full-scale.)
PA CATH 1 1 A FS.		Power amplifier plate and screen grid, shunt resistor and plate supply line circuit current. (Meter calibrated to read 1 ampere full-scale.)
PWR OUT 100 W FS.		Transmitter power output. (Meter calibrated to read 100 watts full-scale.)
MIKE jack -----	When microphone is connected to MIKE jack, and microphone push-to-talk switch is pressed, transceiver switches to transmit mode of operation and transmits voice signals from microphone.	
PHONE jack _____ -----	When headset is connected to PHONE jack, capability is provided to monitor audio output of transceiver.	

3-2. Principles of Operation

a. *General.* Normally, the radio set is operated remotely from the aircraft cockpit with the control unit. The transceiver provides two functional modes of option: transmit and receive. These modes of operation are described in b and c below.

b. *Transmit.* The radio set functions in the transmit mode when operating power is applied and as the push-to-talk switch is held depressed. The push-to-talk switch is not a part of the radio set and may be on the microphone, the control column, the handwheel, or the cockpit floorboards. When the push-to-talk switch is held depressed and the operator speaks into the microphone, the audio signals from the microphone are routed through the C-1611D/AIC and amplitude modulate RF carrier (generated by the

transceiver), and then transmitted into space. When installed in an aircraft the push-to-talk switch and the microphone are usually wired to an intercommunication set (C-1611D/AIC, or equivalent). The C-1611D/AIC amplifies the audio signal before application to the transceiver, and provides internal switching capability to select the desired transceiver for transmission.

c. *Receive.* The transceiver operates in the receive mode of operation whenever power is applied to the radio set and the push-to-talk switch is not pressed; therefore, an amplitude-modulated carrier received at the antenna of the frequency to which the radio set is tuned is demodulated and detected by the transceiver. The detected audio signals are routed through the C-1611D/AIC and amplified and applied to the selected headset for monitoring.

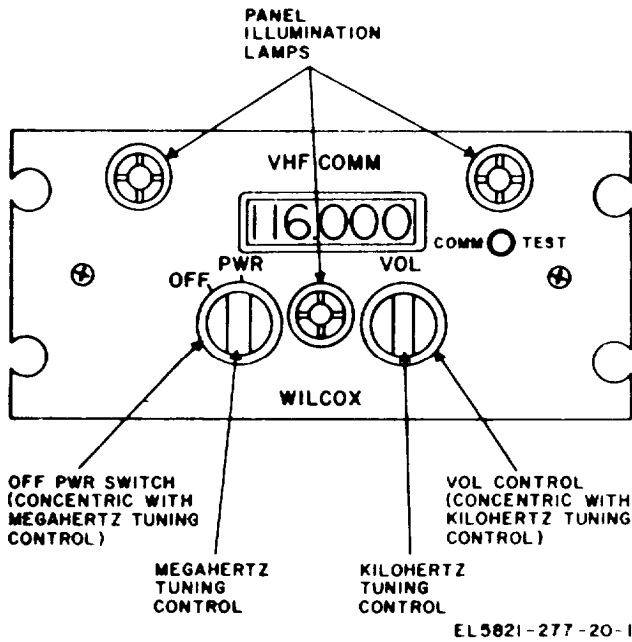

Figure 3-1. Control, Radio Set C-7197/ARC-134, controls and indicator.

3-3. Operating Procedures

NOTE

Plus 27.5 volts must be present on the aircraft direct current (dc) bus when the radio set is operated.

a. *Turn On.* Perform the following operating procedures each time the radio set is turned on.

(1) Check to see that the control unit OFF-PWR switch is set to OFF.

(2) Set the VOL. control to approximately midposition.

(3) Set the C-1611D/AIC controls as required to enable operation of the AN/ARC-134 (*).

(4) A headset must be available to monitor received audio signals. If the headset does not contain a microphone, use an auxiliary so that voice signals can be transmittal.

(5) Set the aircraft master power switch to the on position.

(6) Press the aircraft circuit breaker that supplies power to the C-1611D/AIC.

(7) Press the aircraft circuit breaker that supplies power to the radio set.

(8) Check to see that the control unit panel 'amps light.

(9) Set the OFF-PWR switch to PWR.

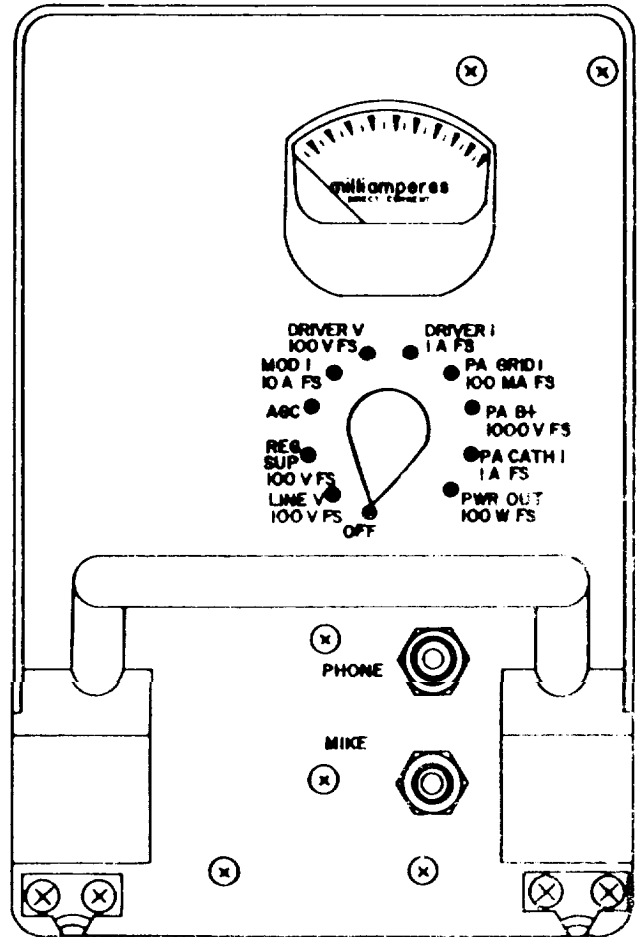

Figure 3-2. Receiver-Transmitter RT-857/ARC-134, controls and indicators.

WARNING

Do not tune the radio set to an emergency operational frequency during the following procedure; otherwise, flight safety of airborne personnel may be endangered.

(1) Set the MHz and kHz. tuning controls as necessary to tune the radio set to a predetermined operational frequency.

(11) Check to see that the desired frequency appears in the VHF COMM frequency indicator window.

(12) Establish two-way voice communication with the monitoring station.

NOTE

Press the push-to-talk switch and speak into the microphone to transmit. Release the push-to-talk switch to receive.

(13) Request that the monitoring station verify that transmitted signals are received clear and free of undue noise or distortion.

(14) Check to see that sidetone is clear and free of distortion during transmission.

(15) Adjust the VOL control knob for a comfortable listening level. Check to see that received audio is clear and free of undue noise or distortion.

b. Normal operation, To operate the radio set, to the desired frequency of operation, monitor the audio output of the transceiver (use the headset in the aircraft), press the push-to-talk switches, and speak into the microphone in the aircraft when transmitting; adjust the control unit VOL control to maintain a comfortable listening level in the headset. The radio set is normally interfaced to an C-1611D/AIC in the aircraft; therefore, operating the C-1611D/AIC controls is an integral part of radio set operation. Refer to the applicable aircraft technical manual for operating instructions for the particular intercommunication set installed on the aircraft.

CAUTION

Tune the radio set only when it is in the receive mode of operation. (The radio set can be tuned to different frequencies while in the transmit mode of operation; however, resultant sudden removal and application of power to the transmitter circuitry is not a good practice.)

(1) Tuning. When tuning the radio set, operate the MHz and kHz tuning controls until the desired frequency appears in the VHF COMM frequency indicator window. The radio set is tuned to the selected frequency within 4

seconds (maximum) after time tuning action is completed.

(2) Monitoring audio output. Application of received, detected audio output from the transceiver to headphones is dependent on control settings of the C-1611D/AIC in the aircraft. The volume of the audio output is controlled by operating the control unit VOL control.

NOTE

The push-to-talk switch must remain pressed during the entire transmitting period.

(3) Transmission. Selection of the radio set for transmission is controlled by the associated C-1611D/AIC installed in the aircraft. When the operating controls on the operator's C-1611D/AIC have been set to select the radio set for transmitting, press the associated push-to-talk switch and speak into the associated microphone in a normal, clear tone.

c. Shutdown.

(1) Set the control unit OFF-PWR switch to OFF.

(2) Deenergize the aircraft circuit breaker that supplies dc power to the radio set.

3-4. Emergency Operation

There are no specific emergency operational procedures for the radio set. If the aircraft intercommunication sets fail, the radio set may be used for two-way voice communication by connecting a microphone and headset (para 1-10) to the MIKE and PHONE jacks on the front panel of the transceiver. Monitor the audio output from the headphone. Press the push-to-talk switch and speak into the microphone when transmitting.

CHAPTER 4
ORGANIZATIONAL MAINTENANCE

Section I. GENERAL

4-1. Scope of Maintenance

The maintenance duties assigned to the organizational maintenance repairman are listed below together with a paragraph reference covering the specific maintenance functions. The duties include instructions for performing both preventive and corrective maintenance procedures. Parts stocked for replacement at the organizational level are listed in TM 11-5821-277-20P.

- a. Daily performance check (paras 4-4 and 4-5).
- b. Intermediate preventive maintenance checks and services (paras 4-6 and 4-7),
- c. Periodic preventive maintenance checks and services (paras 4-8 and 4-9).
- d. Cleaning (para 4-10).
- e. Troubleshooting (paras 4-12 and 4-13).
- f. Removal and replacement of control unit panel lamps (para 4-14).

- g. Removal and replacement of control unit (para 4-16).
- h. Removal and replacement of transceiver (para 4-17).
- i. Removal and replacement of control knobs (para 4-15).
- j. Removal and replacement of resilient mounts (para 4-18).

4-2. Tools, Test Equipment, and Materials Required

The tools, test equipment, and material required for organizational maintenance are listed below.

- a. Tools. All tools required for organizational maintenance are contained in Tool Kit, Electronic Equipment TK-101/G (FSN 5180-064-5178).

b. Test Equipment.

Item	Common name	Purpose	Applicable publication
Headset, Electrical H-216/U.	Headset	Monitor audio output of transceiver from PHONE jack on front panel.	
Microphone M-52B/U.	Microphone	Switch transceiver to transmit mode of operation and transmit voice signals from MIKE jack on transceiver front panel.	TB SIG 330
Multimeter TS-3S2B/U.	Multimeter	Perform continuity checks.	TM 11-6625-366-15

- c. Materials.
- (1) Cleaning compound (FSN 7930-395-9542).

- (2) Brush MIL-G-7241, or equivalent.
- (3) Fine sandpaper No. 000.
- (4) Clean, lint-free cloth.

Section II PREVENTIVE MAINTENANCE PROCEDURES

4-3. Preventive Maintenance

Preventive maintenance is the systematic care, servicing, and inspection of equipment to prevent the occurrence of trouble, reduce downtime, and maintain equipment serviceability.

- a. Systematic Care. The procedures given in paragraphs 4-4 through 4-10 cover routine, systematic care and cleaning essential to proper up keep and operation of the equipment.
- b. Preventive Maintenance Checks and Services. The preventive maintenance checks and

services charts (paras 4-4 through 4-9) outline inspections and tests to be performed at specific intervals. The inspections and tests are made to maintain Army electronic equipment in a combat-serviceable condition; that is, to maintain the equipment in good general (physical) condition; and in good operating condition. To assist the organizational maintenance repairman in maintaining combat serviceability, the charts indicate what to inspect, how to inspect, and what the normal conditions are; the References column lists the paragraphs or manuals that contain supplementary information. If a defect cannot be remedied by the organizational maintenance repairman, higher category maintenance or repair is required. Records and reports of these inspections must be made in accordance with the requirements set forth in TM 38-750.

4-4. Test Procedure Information

a. The test procedures given in paragraph 4-5 should be performed each day the radio set is to be used, when troubleshooting the equipment, subsequent to removal and replacement of major radio set components, and subsequent to initial installation.

b. Perform the checks in the order listed. When an abnormal result is noted, refer to the reference listed under If result is abnormal

column and perform the corrective actions listed.

c. Two personnel are required to perform certain portions of the test: one man operates the push-to-talk switch and speaks into the microphone in the cockpit of the aircraft, while another man operates the meter selector switch and logs the meter indications at the transceiver location.

d. The meter indications listed are typical and will vary slightly between radio sets, therefore, the organizational maintenance repairman should maintain a log of the meter indications. Sudden, drastic changes in meter indications indicate that the radio set is malfunctioning or that radio set operation has deteriorated and trouble is imminent. In either case, the transceiver should be replaced (para 4-17) and the performance check repeated to verify that typical meter indications are obtained.

e. The aircraft C-1611D/AIC should be used during performance of the check; otherwise, results will not be valid.

NOTE

27.5 volts dc must be present on the aircraft main & bus during the performance check. To prevent current drain on the aircraft batteries, the aircraft engine(s) should be running or an auxiliary power unit should be connected to the aircraft.

4-5. Test Procedures

Item No.	Procedure	Normal result	If result is abnormal
1	Set aircraft master power switch on.	None.	
2	Energize 27.5-volt dc circuit breakers that supply power to radio set, and C-1611D/AIC associated with radio act.	Panel lamps should light, illuminating panel markings on control Unit.	Para 4-13, item L
3	Set controls on C-1611D/AIC as necessary to enable operation of radio act.	None.	
4	Set control unit OFF-PWR switch to PWR.	Indicators in VHF COMM frequency indicator tuning window should light.	Para 4-13, item 76.
5	Tune radio set to predetermined frequency.	Selected frequency should appear in VHF COMM frequency indicator window.	Para 4-13, item 6.
6	Establish two-way voice communication with local am. station operating on frequency selected in item 5 above, and adjust control unit VOL control as necessary to obtain comfortable listening level from headset.	a. Transmitted signals should be received clear and audible at local station. b. When signals are being transmitted, sidetone monitored by headset should be clear and audible	Para 4-13, item 9. Para 4-13, item 8.
7	Rotate control unit VOL control clockwise, then counterclockwise while receiving a signal	c. Signals received from local a.m. station should be clear and audible Volume of received signal should increase where VOL control is rotated clockwise, and decreased when VOL control is rotated counterclockwise.	Para 4-13, item 10. Para 4-13, item 15.
8	Depress push-to-talk switch.	Blower in transceiver operates.	Para 4-13, item 3.

Item No.	Procedure	Normal result	If result is abnormal
9	During periods of no signal reception, monitor output of transceiver.	Output should be silent	Para 4-13, item
10	During period of no signal reception, Press COMM TEST switch while monitoring output of transceiver with headset	Noise should be present in headset where COMM TEST switch is pressed, indicating squelch circuitry is operative.	Para 4-13, item 10.
11	transceiver meter selector switch to LINE V 100 V FS. Note and record monitor meter indication.	27 volts \pm 1.	Para 4-13, item 4.
12	Set transceiver meter selector switch to REG SUP 100 V FS. Note and record monitor meter indication.	20 volts \pm 0.5.	Para 4-13, item 4.
13	Set transceiver meter selector switch to AGC. Note and record monitor meter indication.	No signal applied, 0.06 (1 scale division) ; with signal applied, 0.05 to 0.60 (16 scale divisions) depending on input signal level.	Para 4-13, item 4.
14	Set transceiver meter selector switch to MOD 1 10 A FS. Press push-to-talk switch, speak into microphone in normal voice, and note and record meter indication.	2.0 to 2.5 amperes (3.5 amperes maximum).	Para 4-13, item 4.
15	Set transceiver meter selector switch to DRIVER V 100 V FS. Press push-to-talk switch and note and record monitor meter indication.	33 volts \pm 15 percent.	Para 4-13, item 4.
16	Set transceiver meter selector switch to DRIVER I 1 A FS. Press push-to-talk switch and note and record monitor meter indication.	Dependent on transmitter frequency 150 to 300 milliamperes (60 milliamperes minimum; 500 milliamperes maximum).	Para 4-13, item 4.
17	Set transceiver meter selector switch to PA GRID I 100 MA FS. Press push-to-talk switch. Note and record monitor meter indication.	Dependent on transmitter frequency 15 to 25 milliamperes (40 milliamperes maximum) .	Para 4-13, item 4.
18	Set transceiver meter selector switch to PA B+ 1000 V FS. press push-to-talk switch and note and record monitor meter indication.	400 volts \pm 16 percent	Para 4-13, item 4.
19	Set transceiver meter selector switch to PA CATH I 1 A FS. press push-to-talk switch and note and record monitor meter indication.	Dependent on transmitter frequency 160 to 200 milliamperes (300 milliamperes maximum.)	Para 4-13, item 4.
20	Set transceiver meter selector switch to PWR OUT 100 W FS. Press push-to-talk switch and note and record monitor meter indication	25 watts minimum.	Para 4-13, item 4.
21	Set transceiver meter selector switch to OFF.	None.	
22	Set control unit OFF-PWR switch to OFF.	None.	

TM 11-5821-277-20

Item No.	Procedure	Normal result	If result is abnormal
23	Deenergize 27.5-volt dc circuit breakers that supply power to radio set and C-1611D/AIC.	None	
24	Set master aircraft power switch to off position.	None.	

¹Since monitor meter indications obtained are dependent on transmitter frequency, same frequency should be used each time monitor indications are accomplished.

4-6. Intermediate Preventive Maintenance Checks and Services

Intermediate inspection provides verification of satisfactory operation at intervals of 25 flying hours and will be performed concurrently with the intermediate inspection performed on the aircraft in which the equipment is installed. The maintenance interval must be adjusted to compensate for any unusual operating conditions. Inter-

mediate maintenance must be performed on equipment maintained in a standby (ready for operation) condition concurrently with the intermediate inspection performed on the carrying aircraft that is in a standby condition. Equipment with a deficiency that cannot be remedied at the organizational category should be deadlined in accordance with instructions given in TM 38-760.

4-7. Intermediate Preventive Maintenance Checks and Services Chart

Sequence No.	Item to be Inspected	Procedure	References
POWER OFF-INSPECTION			
1	Transceiver _____	a. Clean all exposed, exterior surfaces. b. Check to see that the meter selector switch is firmly secured to its mounting shaft. c. Rotate meter selector switch through all settings; note that switch does not bind and positive detent action occurs at detent positions. d. Check to see that transceiver is firmly seated in mounting. e. Check to see that holddown clamps that secure transceiver in mounting are tight. f. If safety wire is used to secure hold-down clamps, note that wire is tight and not frayed or otherwise damaged.	a. Para 4-10. b. None. c. None. d. None. e. None. j. None.
2	Control unit -----	a. Clean front panel. b. Check to see that four quick-release fasteners that secure control unit to instrument panel are secure. c. Check to see that three panel lamp-holders on front panel are secure. d. Note that VHF COMM frequency indicator window is secure and not damaged. e. Check front panel controls for obvious physical damage. f. Rotate OFF-PWR switch to OFF, then to PWR; note that smooth positive switching action occurs. g. Rotate VOL control throughout its operating range; note that it does not bind and that it does not rotate too freely.	a. Para 4-10. b. None. c. None. d. None. e. None. f. Noms g. None

Sequence No.	Item to be Inspected	Procedure	References
		h. Rotate MHz and kHz tuning controls to left until a stop is encountered on MHz tuning control, and last three digits displayed by VHF COMM frequency indicator are 000. Note that 116.000 is displayed by VHF COMM frequency indicator.	h. None.
		i. Rotate MHz tuning control to right; note that second two digits from left on VHF COMM frequency indicator increase by 1 at each detent position and the highest number obtained is 149.000.	i. None
		j. Rotate kHz tuning control to right; note that last three digits displayed on VHF COMM frequency indicator increase 25 kHz at each detent position.	j. None.
		k. Verify that COMM TEST switch is firmly secured to front panel.	k. None
3	Cables and connectors -----	Check interconnecting cabling for evidence of fraying or excessive strain.	None.
4	Mounting -----	a. Check to see that mounting is securely fastened to aircraft frame. b. Check to see that ground strap is securely fastened to aircraft frame. c. Check to see that resilient (shock) mounts operate smoothly.	a. None. b. None. c. Nom
POWER-ON INSPECTION			
5	Primary power _____	Set aircraft primary power switch to on and close circuit breakers that supply 27.5 volts dc to radio set and C-1611D/U. Control unit panel lamps should light.	a. Refer to appropriate aircraft manual.
6	Radio set power -----	b. Set control unit OFF-PWR to PWR. VHF COMM frequency indicator should light.	b. None.
7	Tuning -----	a. Tuning radio set to predetermined frequency of local am. station. Tuning action by radio set should be completed in less than 4 seconds. b. Set controls on aircraft C-1611D/AIC as required to operate radio set.	a. None b. Applicable aircraft manual
8	Blower -----	Press an aircraft push-to-talk switch; tranceiver blower should operate.	None.
9	Two-way communication operation.	Establish two-way voice communication with local a.m. station to which radio set is tuned. Check to see that transmitted signals are received clear and audible. Be sure that sidetone and received signals are clear and audible.	Para 3-3.

4-8. Periodic Preventive Maintenance Checks and Services

Perform the preventive maintenance indicated in the periodic preventive maintenance checks and

services chart once each periodic interval in addition to the intermediate preventive maintenance checks and services. The periodic preventive maintenance should be performed every 100

flying hours, concurrently with the aircraft periodic preventive maintenance service schedule of the aircraft in which the radio set is installed to reduce out-of-service time. Perform all the checks

and services given in the chart in the sequence listed. Record all deficiencies in accordance with the requirement of TM 38-750,

4-9. Periodic Preventive Maintenance Checks and Services Chart

Sequence No.	Item to be inspected	Procedure	References
1	Completeness -----	Be sure that radio set, is complete.	Fig. 1-1.
2	publications -----	Check to see that all pertinent publications are available. Technical manuals must be complete and in useable condition with all applicable changes posted.	DA Para 310-4.
3	Modification work orders -----	Check to see that all URGENT MWO's have been applied to equipment and all NORMAL MWO's have been scheduled.	DA Para 310-7.
4	Control unit -----	a. Remove control unit from instrument and check for dirt and corrosion. b. Clean control unit. c. Inspect electrical connector at rear of control unit for signs of obvious physical damage. d. Reinstall control unit.	a. Para 4-16. b. Para 4-10. c. None. d. Para 4-16.
6	Transceiver -----	a. Remove transceiver from mounting and inspect for dirt and corrosion. b. Clean transceiver. c. Carefully inspect dual electrical connector at rear of transceiver (fig. 1-7) for signs of physical damage or evidence of improper mating.	Para 4-17. b. Para 4-10. c. None.
6	Mounting -----	a. While transceiver is removed, check mounting for dirt and corrosion accumulation. b. Clean mounting. c. Carefully inspect dual feedthrough electrical connector at rear of mounting for evidence of physical damage or improper mating. Also check to be sure that aircraft wiring is securely soldered, or otherwise connected, to pins at rear of receptacle. d. Be sure that grounding strap is securely fastened to frame of aircraft. e. Be sure that mounting is securely fastened to frame of aircraft. f. Check to see that resilient (shock) mounts operate smoothly and supply prescribed distance of travel. Sequentially press and lift up each end of mounting. Shockmount should permit mounting to travel both down and up one-sixth of an inch from normal loaded position.	a. Para 4-11. b. Para 4-10. c. None. d. None. e. None. f. None
7	Transceiver -----	Replace transceiver in mounting.	Pm-a 4-17.
8	Radio set -----	a. Perform power-on procedure. b. Accomplish test procedures.	a. Para 4-7. b. Para 4-7.

Sequence No.	Item to be Inspected	Procedure	References
		a. Remove power by setting control unit OFF-PWR switch to OFF, denergizing 27.5-volt dc circuit breakers that supply power to radio set and C-1611D/AIC, and setting aircraft master power switch to off position.	c. None.

4-10. Cleaning

All exterior surfaces of the equipment should be free of dirt, grease, and fungus. Perform the following procedures as necessary when cleaning the components of the radio set.

a. Remove loose dirt and moisture from large, flat surfaces and front panels with a soft, clean cloth. If dirt is difficult to remove, dampen the cloth with water. For more effective cleaning, use a mild soap solution in the water. If a wet cloth is used, dry wet surfaces thoroughly after cleaning.

b. Remove loose dirt from cable and equipment connectors with a soft brush.

WARNING

Prolonged breathing of cleaning compound is dangerous; make sure that ade-

quate ventilation is provided. Cleaning compound is flammable; do not use near a flame. Avoid contact with the skin; wash off any that spills on the trends.

c. Remove grease, grime, and fungus with a cloth moistened (not wet) with the cleaning compound; wipe the area thoroughly dry.

4-11. Repainting and Refinishing

Remove rust and corrosion from metal surfaces by lightly sanding them with fine sandpaper. Brush two thin coats of paint on the bare metal to protect it from further corrosion. Refer to SB 11-573 to determine the paint or preservative to be used. Refer to TB 746-10) for applicable cleaning and refinishing practices.

Section III. TROUBLESHOOTING

4-12. General

Troubleshooting at the organizational category of maintenance is generally limited to isolating the cause of trouble to major components of the radio set, to improper mating of connectors. Also, the organizational maintenance repairman may replace defective control units, transceivers, panel lamps, and control knobs. Troubleshooting the radio set is based on the test procedures (para 4-5). When troubleshooting the equipment, perform the procedure in the sequence listed. When

an abnormal indication or result is obtained, locate the symptom in the troubleshooting chart below and perform the checks and corrective measures indicated. If the trouble is not corrected, higher category maintenance is required. When a defective transceiver or control unit is isolated and replaced at the organizational category of maintenance tag the equipment in accordance with instructions given in TM 33-750 and forward the equipment to a higher category maintenance for repair.

4-13. Troubleshooting Chart

Item No.	Trouble symptom	Probable trouble	Checks and corrective measures
1	Control unit panel lamp(s) do not light when 27.5- volt dc circuit breaker is energized.	a. Panel lamp(s) defective. b. Power not supplied to radio set.	a. Check panel lamps; replace as necessary (para 4-14). b. Set control unit OFF-PWR switch to PWR. Interior lamps should light the VHF COMM frequency indicator: If this does not occur, powerline to radio set may be open. Refer to higher category maintenance for aircraft wiring repair.

Item No.	Trouble symptom	Probable trouble	Checks and corrective measures
2	Aircraft 27.5-volt dc circuit breaker opens when control unit OFF-PWR switch in set to PWR.	Primary power shorted in control unit or transceiver.	Remove and replace control unit (para 4-16). If trouble is not corrected, remove and replace transceiver (para 4-17). If trouble is not corrected refer to higher category maintenance for check of aircraft wiring connecting control unit and mounting.
8	Transceiver blower does not operate when push-to-talk switch is pressed (radio ant operates properly otherwise) .	Defective blower motor -----	Replace transceiver (para 4-17).
4	Monitor meter indications are abnormal.	Transceiver circuitry -----	Replace transceiver (pare 4-17).
5	Tuning controls do not operate VHF COMM frequency indicator as specified.	a. Tuning controls loose on mounting shaft.	a. Tighten setscrews that secure tuning controls to their respective mounting shafts. Replace if necessary (para 4-15).
6	Radio set will not tune to selected frequency (tuning controls operate properly).	a. Control unit defective ----- a. Control unit defective ----- b. Transceiver defective ----- c. Interconnecting cabling -----	b. Replace control unit (para 4-16). a. Replace control unit (para 4-16). b. Replace transceiver (para 4-17) c. Refer to higher category maintenance for isolation and repair of defective cabling.
7	Radio set inoperative (aircraft circuit breaker supplying power to radio set energized).	a. Connectors not securely mated ----	a. Remove control unit from instrument panel (para 4-16) and check to see that aircraft wiring harness connector is securely mated with connector J1 at rear of control unit. Also check to see that connectors on transceiver and mounting are securely mated.
8	Radio set transmits but no sidetone signal heard in headset.	b. Control unit OFF-PWR is defective a. Aircraft C-1611D/AIC defective ---	b. Replace control unit (pars 4-16). a. Connect headset and microphone directly to PHONE and MIKE jacks on transceiver and operate radio set. If equipment operates properly, trouble is isolated to aircraft C-1611D/AIC. Refer C-1611D/AIC to higher category maintenance repair.
9	Radio set operates properly in mode but will not transmit,	b. Transceiver defective ----- a. Aircraft C-1611D/AIC defective __	b. Replace transceiver (para 4-17). a. Connect headset and microphone directly to transceiver and operate radio set. If equipment operates properly, trouble is isolated to aircraft C-1611D/AIC. Refer C-1611D/AIC to higher category maintenance for repair.
10	Radio set operates properly in transmit mode but will not receive.	b. Transceiver defective ----- a. Transceiver squelch control not properly adjusted. b. Aircraft C-1611D/AIC defective --- c. Transceiver defective -----	b. Replace transceiver (para 4-17), a. Press COMM TEST switch on control unit during periods of signal reception. If signal is received, squelch control is not properly adjusted. Replace the transceiver (pare 4-17). b. Connect headset to PHONE jack on transceiver. If audio is received, trouble is isolated to the aircraft C-1611D/AIC. Refer C-1611D/AIC to higher category maintenance for repair. c. Replace transceiver (para 4-17).

<i>Item No.</i>	Trouble symptom	Probable trouble	<i>Checks and corrective measures</i>
11	Excessive noise in headset during periods of no signal reception.	Transceiver squelch control not adjusted properly.	Replace transceiver (para 4-17).
12	Audio signals are distorted, or contain excessive hum.	a. Transceiver defective ----- b. Aircraft C-1611D/AIC defective ___	Replace transceiver (para 4-17). b. Connect headset and microphone directly to transceiver PHONE and MIKE jacks and operate radio act. If distortion or excessive hum is no longer present, trouble is isolated to C-1611D/AIC. Refer C-1611D/AIC to higher category maintenance for repair.
		c. Audio cables defective, or shield not properly grounded.	c. Request higher category maintenance check of audio cabling.
13	Radio set operates on some frequencies but not on others.	a. Control unit defective b. Transceiver defective -----	a. Replace control unit (para 4-16). b. Replace transceiver (para 4-17).
14	Reception and transmission very weak	a. Transceiver defective ----- b. Antenna or antenna rf interconnecting cabling defective.	a. Replace transceiver (para 4-17). b. Request higher category maintenance check of antenna and associated rf cabling.
15	Operation of Control Unit VOL control does not change received audio signal.	VOL control defective .-----	Replace control unit (para 4-16).
16	Mounting does not operate smoothly or provide specified limits of travel to protect transceiver from shock and vibration.	Worn or damaged resilient mount(s)	Replace resilient mounts as necessary (para 4-18).

Section IV. REMOVAL AND REPLACEMENT

4-14. Control Unit Panel Lamp

WARNING

Be sure that the 27.5-volt dc circuit breaker that supplies power to the radio set is deenergized before performing the procedures given below.

NOTE

Check to see that the washer and rubber ring remain in place on the lampholder during removal procedures.

- a. Unscrew the defective lampholder from the panel.
- b. Remove the defective lamp from holder with a sharp-bladed instrument to separate the base of the lamp from the holder,
- c. Insert a new lamp firmly into the holder.
- d. **Screw** the lampholder firmly into the front panel of the control unit.

4-15. Control Unit Control Knobs

a. The MHz timing control knob and the OFF-PWR switch are on the same mounting shaft, and the VOL. control knob and the kHz tuning control knob are on the same mounting shaft (fig. 3-1); however, each of the knobs is a separate, independent section. When replacing the rear sections, it is necessary to first remove the associated tuning control knob.

b. Perform the procedures given below when removing and replacing the control knobs.

CAUTION

When replacing a rear section knob, check to see that it does not drag or bind against the front panel of the control unit after the setscrews that hold it in place have been tightened. Also check to see that the front knob does not bind or drag against the rear knob after the setscrews have been tightened.

(1) Note or mark the position of the front knob which is to be removed in relation to the front panel of the control unit.

(2) Loosen the two setscrews that secure the knob to the mounting shaft.

(3) Slide the knob off the mounting shaft. If the front knob is to be replaced, proceed to (9) below. If a rear knob is to be replaced proceed to (4) below'.

(4) Note the position of the rear control knob.

(5) Loosen the two setscrews that secure the rear knob to the mounting shaft.

(6) Slide the knob off the shaft and slide the new knob) into place; be sure that, the physical orientation is the same as that of the removed knob.

(7) Note that sufficient clearance exists between the rear of the knob and the front panel of the control unit to prevent binding when the knob is rotated.

(8) Hold the knob in place and tighten the two screws that secure the knob to the shaft.

(9) Insert either a new knob or the knob removed in (3) above on the mounting shaft; be sure that physical orientation is the same as the removed knob.

(10) Tighten the two setscrews that secure the knob to the mounting shaft.

(11) Rotate the knob to be sure that it does not bind or drag against the rear knob.

4-16. Control Unit

WARNING

Be sure that the aircraft master power switch is off and the 27-volt dc circuit breaker that supplies power to the radio set is deenergized before performing the procedures given below.

CAUTION

Be careful not to place undue strain on the aircraft cabling while performing the procedures.

a. Loosen the four quick-release fasteners (fig. 1-1) that secure the control unit to the aircraft instrument panel (or other applicable mounting).

b. Pull the control unit straight out of its mounting until connector J1 at the rear of the unit can be reached.

c. Disconnect the aircraft wiring harness plug from connector J1 at the rear of the control unit.

d. Carefully mate the aircraft wiring harness plug with connector J1 at the rear of the control

unit replacement; push the plug firmly into connector J1 and turn the outer shell to lock it in place.

e. Insert the control unit into its mounting slot.

f. Hold the control unit in place and turn the four quick release fasteners to secure the control unit to the instrument panel.

g. Perform the performance checks given in paragraph 4 5 to insure that the radio set is operational.

4-17. Transceiver

WARNING

Be sure that the 27.5volt dc circuit breaker that supplies power to the radio set is deenergized before performing the procedures given below.

a. Removal.

(1) If safety wire is used to secure the holddown clamps that secure the transceiver in the mounting, note how the safety wire is affixed and remove from the holddown clamps.

(2) Loosen the two nuts (fig. 1-6) that secure the holddown clamps in the place over the holddown brackets on the transceiver and slide the holddown clamps off the holddown brackets.

(3) Grasp the handle on the front panel of the transceiver and carefully pull straight forward to disengage the mating connectors on the transceiver and mounting (fig. 1-5).

(4) Slide the transceiver forward out of the mounting.

b. Replacement.

(1) Place the transceiver between the mounting guide rails and push the transceiver straight into the mounting until the mating connectors just touch.

(2) Check to see that the locating pins on the mounting (fig.1-1) mate properly with the transceiver.

(3) Firmly push the transceiver straight back to insure a secure mating of the connectors on the mounting and the transceiver.

(4) Place the holddown clamps in place over the holddown brackets on the transceiver and tighten the nuts that secure the holddown Clamps.

(5) If safety wire was removed in (1) above, replace the safety wire.

(6) Perform the performance checks outlined in paragraph 4-5 to be sure that the radio set is operational.

4-18. Resilient Mount**WARNING**

Be sure that the 27.5-volt dc circuit breaker that supplies power to the radio set is deenergized before performing the procedures given below.

a. Remove the transceiver from the mounting (para 4-17).

a.1 Remove the four screws that secure the connector to the bracket at the rear of the mount and push the connector out of the mount

b. Remove the four Phillips-head screws (fig. 1-1) that secure the resilient mounts to the mounting.

c. Move the mounting so that the screws that secure the defective mounts to the aircraft frame can be reached.

d. Remove the four screws that secure the defective mounts to the aircraft frame.

e. Replace the defective mounts and secure with the four screws removed in *d* above.

f. Set the mounting in place over the mounts; be sure that the ground strap is located between the mounting and the proper mount.

NOTE

On Mounting MT-3791/ARC-134, there are four ground straps, one for each resilient mount.

g. Secure the mounting to the mounts with the screws removed in *b* above.

g.1. Replace the connector and secure with hardware removed in *a.1* above.

h. Replace the transceiver in the mounting (para 4-17).

APPENDIX A

REFERENCES

The following publications contain information applicable to the maintenance of Radio Set AN/ARC 134(*).

AR 700-58	Report of packaging and handling Deficiencies.
DA Pam 310-4	Index of Technical Manuals, Technical Bulletins, Supply Manuals (types 7, 8, and 9), Supply Bulletins and Lubrication Orders.
DA Pam 310-7	U.S. Army Equipment Index of Modification Work Orders.
SB 11-573	Painting and Preservation Supplies Available for Field Use for Electronics Command Equipment.
SB 38-100	Preservation, Packaging, Packing, and Marking Materials, Supplies, and Equipment Used by the Army.
TB SIG 330	Microphone M-52/U and M-52A/U.
TB 746-10	Field Instructions for Painting and Preserving Electronic Command Equipment.
TM 9-213	Painting Instructions for Field Use.
TM 11-5831-201 15	Organizational, DS, GS, and Depot Maintenance Manual (Including Repair Parts and Special Toed Lists) Controls, Intercommunication Set C-1611/AIC, C-1611A/AIC, C-1611B/AIC, C-1611C/AIC, and C-1611D/AIC.
TM 11-5965-215-15	Operator, Organizational, Field and Depot Maintenance Manual: Headset-Microphone H-101A/U.
TM 11-6625-366-15	Organizational, DS, GS, and Depot Maintenance Manual: Multimeter TS-352(B)/U.
TM 38-750	Army Equipment Record Procedures.
TM 740-90-1	Administrative Storage of Equipment.
TM 750-244-2	Procedures for Destruction of Electronic Materiel to Prevent Enemy Use (Electronics Command)

APPENDIX B

MAINTENANCE ALLOCATION

B-1. General

This appendix provides a summary of the maintenance operations covered in the equipment literature. It authorizes categories of maintenance for specific maintenance functions on repairable items and components and the tools and equipment required to perform each function. This appendix may be used as an aid in planning maintenance operations.

B-2. Maintenance Functions

Maintenance functions will be limited to and defined as follows:

a. Inspect. To determine the serviceability of an item by comparing its physical, mechanical, and or electrical characteristics with established standards through examination.

b. Test. To verify serviceability and to detect incipient failure by measuring the mechanical or electrical characteristics of an item and comparing those characteristics with prescribed standards.

c. Service. operations required periodically to keep an item in proper operating rendition, i.e., to clean, preserve, drain, paint, or to replenish fuel/lubricants hydraulic fluids or compressed air supplies.

d. Adjust. Maintain within prescribed limits by bringing into proper or exact position, or by setting the operating characteristics to the specified parameters.

e. Align. To adjust specified variable elements of an item to about optimum or desired performance.

f. Calibrate. To determine and cause corrections to be made or to be adjusted on instruments or test measuring and diagnostic equipment used in precision measurement. Consists of the comparison of two instruments, one of which is a certified standard of known accuracy, to detect and adjust any discrepancy in the accuracy of the instrument being compared.

g. Install. The act of emplacing, seating or fixing into position an item, part, module (component or assembly) in a manner to allow the proper functioning of the equipment/system.

h. Replace. The act of substituting a serviceable like-type part, subassembly, module (component or

assembly) in a manner to allow the proper functioning of the equipment/system.

i. Repair. The application of maintenance services (inspect, test, service, adjust, align, calibrate, replace) or other maintenance actions (welding, grinding, riveting, straightening, facing remachining, or resurfacing) to restore serviceability to an item by correcting specific damage, fault, malfunction, or failure in a part, subassembly, module, component/assembly, end item or system.

j. Overhaul. That maintenance effort (service/action) necessary to restore an item to a completely serviceable/operational condition as prescribed by maintenance standards (e.g., DMWR) in pertinent technical manuals. Overhaul is normally the highest degree of maintenance performed by the Army. Overhaul does not normally return an item to like-new condition.

k. Rebuild. Consists of those services actions necessary for the restoration of unserviceable equipment to a like-new condition in accordance with original manufacturing standards. Rebuild is the highest degree of materiel maintenance applied to Army equipment. The rebuild operation includes the act of returning to zero those age measurements (hours, miles, etc.) considered in classifying Army equipment/components.

l. Symbols. The uppercase letter placed in the appropriate column indicates the lowest level at which that particular maintenance function is to be performed.

B-3. Explanation of Format

a. Group Number. Column 1 lists group numbers, the purpose of which is to match components, assemblies, subassemblies and modules with the next higher assembly.

b. Functional Group. Column 2 lists the next higher assembly group and the item names of components, assemblies, subassemblies and modules within the group for which maintenance is authorized.

c. Maintenance Functions. Column 3 lists the twelve maintenance functions defined in B-2 above. Each maintenance function required for an item is specified by the symbol among those listed in *d* below which indicates the level responsible for the required maintenance. Under this symbol is listed an approp-

TM 11-5821-277-20

riate work measurement time value determined as indicated in e below.

d. *Use of Symbols.* The following symbols are used to prescribe work function responsibility:

- C — Operator/Crew
- O — Organization
- F — Direct Support
- H — General Support
- D — Depot

e. *Work Measurement Time.* The active repair time required to perform the maintenance function is included directly below the symbol identifying the category of maintenance. The skill levels used to obtain the measurement times approximate those found in typical TOE units. Active repair time is the average aggregate time required to restore an item (subassembly, assembly, component, module, end item or system) to a serviceable condition under typical field operating conditions. This time includes preparation time, fault isolation/diagnostic time, and QA/QC time in addition to the time required to perform specific maintenance functions identified for the tasks authorized in the maintenance allocation chart. This time is expressed in man-hours and carried to one decimal place (tenths of hours).

f. *Tools and Test Equipment.* This column is used to specify, by code, those tools and test equipment required to perform the designated function.

g. *Remarks.* Self-explanatory.

B-4. Explanation of Format of Table B2-1, Tool and Test Equipment Requirements

The columns in Table B2-1, Tool and Test Equipment Requirements, are as follows:

a. *Tools and Equipment.* The numbers in this column coincide with the numbers used in the tools and equipment column of the applicable tool for the maintenance function.

b. *Maintenance Category.* The codes in this column indicate the maintenance category normally allocated the facility.

c. *Nomenclature.* This column lists tools, test, and maintenance equipment required to perform the maintenance functions.

d. *Federal Stock Number.* This column lists the Federal stock number of the specific tool or test equipment.

NOTE

For requisitioning purposes, the Federal stock number must be converted to the National stock number by adding “-00-” after the Federal stock classification (FSC) code (first four digits). For example, FSN 6625-553-0142 converts to NSN 662500-553-0142.

e. *Tool Number.* Not applicable.

SECTION II. MAINTENANCE ALLOCATION CHART

MAINTENANCE ALLOCATION CHART															
(1) GROUP NUMBER	(2) FUNCTIONAL GROUP COMPONENT ASSEMBLY NOMENCLATURE	(3) MAINTENANCE FUNCTIONS										(4) TOOLS AND EQUIPMENT	(5) REMARKS		
		INSPECT	TEST	SERVICE	ADJUST	ALIGN	CALIBRATE	INSTALL	REPLACE	REPAIR	OVERHAUL			REBUILD	
01	RADIO SET AN/ARC-134	0 0.5	0 0.5	0 0.5					0 1.0					9, 16	Organizational test limited to equipment operation, and repair limited to replacement of radio set components and repair as indicated
			F 1.0								F 2.0			1 thru 8, 11 thru 15, 18, 19, 20 1 thru 20	Testing is limited to radio set components and repair as indicated
0101	RECEIVER-TRANSMITTER RT-857/ARC-134	0 0.5 0 0.5		0 0.5									D 10.0	16	Verify operation
											F 1.0			9, 16 6, 17, 18	Receptacles, plugs, and wiring
								0 0.5	0 0.5		F 2.0			16	Replacement of transceiver unit
		F 0.5	F 1.0		F 1.0			F 0.5	F 0.5	F 2.0				1 thru 8, 11 thru 15, 18, 19, 20	Preliminary tests
		F 0.5	F 1.0							F 2.0				10	Plug-in transistors
		F 0.5	F 1.0	F 0.5	F 0.5	F 1.0		F 5.0	F 0.5					9, 10, 17	Chassis and circuit boards i.e., receiver transmitter, r.f. drive, etc.
		F 0.5	F 1.0	F 0.5							H 3.0	H 5.0		6, 10, 18 13, 14	
		F 0.5	F 1.0	F 0.5	F 1.0			F 0.5	F 0.5					6, 17	Blower and positioning motors
											H 3.0	H 5.0		6, 17, 18	
		F 0.5	F 1.0							F 2.0				6, 15, 17	Power transformer and associated filtering
												H 5.0		6, 15, 17, 18	

SECTION II. MAINTENANCE ALLOCATION CHART - (CONTINUED)

MAINTENANCE ALLOCATION CHART																
(1) GROUP NUMBER	(2) FUNCTIONAL GROUP COMPONENT ASSEMBLY NOMENCLATURE	(3) MAINTENANCE FUNCTIONS										(4) TOOLS AND EQUIPMENT	(5) REMARKS			
		INSPECT	TEST	SERVICE	ADJUST	ALIGN	CALIBRATE	INSTALL	REPLACE	REPAIR	OVERHAUL			REBUILD		
0102	AN/ARC-134 (Continued) CONTROL, RADIO SET C-7197/ARC-134	0 0.5	F 1.0	F 0.5		H 1.0	H 2.0		F 0.5	F 1.0		H 3.0	H 5.0	D 10.0	6, 18 1 thru 8 11 thru 15, 18 1 thru 20 16 17 6, 18 6, 17, 18	Receiver-transmitter low, high oscillator
0103	MOUNTING ME-3791/ARC-134	0 0.5		F 0.5						F 1.0	F 2.0			D 10.0	16 6, 17, 18	

TABLE B2-1. TOOL AND TEST EQUIPMENT REQUIREMENTS

TOOL AND TEST EQUIPMENT REQUIREMENTS				
TOOLS AND EQUIPMENT	MAINTENANCE CATEGORY	NOMENCLATURE	FEDERAL STOCK NUMBER	TOOL NUMBER
		AN/ARC-134 (Continued)		
1	F,H,D	GENERATOR, SIGNAL AN/USM-44	6625-669-4031	
2	F,H,D	COUNTER, ELECTRONIC DIGITAL READOUT AN/USM-207	6625-911-3638	
3	F,H,D	VOLTMETER, ELECTRONIC ME-30(*)/U	6625-643-1670	
4	F,H,D	GENERATOR, SWEEP SIGNAL AN/USM-203(*)	6625-086-7165	
5	F,H,D	GENERATOR, SIGNAL AN/URM-127	6625-783-5965	
6	F,H,D	MULTIMETER, METER ME-26(*)	6625-646-9409	
7	F,H,D	OUTPUT METER, AUDIO TS-585(*)/U	6625-244-0501	
8	F,H,D	OSCILLOSCOPE AN/USM-140(*)	6625-987-6603	
9	O	MULTIMETER TS-352(B)/U	6625-242-5023	
10	F,H,D	TEST SET, TRANSISTOR TS-1836/U	6625-893-2628	
11	F,H,D	THRU-LINE WATTMETER AN/URM-120	6625-813-8436	
12	F,H,D	VOLTMETER, DIGITAL AN/GSM-64(*)	6625-870-2264	
13	F,H,D	HEADSET, ELECTRICAL H-216(*)/U	5965-892-3353	
14	F,H,D	MICROPHONE M-52A/U	6965-646-4678	
15	F,H,D	MAINTENANCE KIT, ELECTRONIC EQUIPMENT MK-1004(*)/ARC	5821-926-7292	
16	O	TOOL KIT, ELECTRONIC EQUIPMENT TK-101/G	5180-064-5178	
17	F,H,D	TOOL KIT, ELECTRONIC EQUIPMENT TK-100/G	5180-605-0079	
18	F,H,D	TOOL KIT, ELECTRONIC EQUIPMENT TK-105/G	5180-610-8177	
19	F,H,D	DUMMY LOAD, ELECTRICAL DA-75/U	5985-280-3480	
20	F,H,D	VARIABLE ATTENUATOR CN-608/U	6625-626-5506	

By Order of the Secretary of the Army:

W. C. WESTMORELAND,
General, *United States Army*,
Chief of Staff.

Official:

KENNETH G. WICKHAM,
Major General, *United States Army*,
The Adjutant General.

Distribution:

To be distributed in accordance with DA Form 12-36. Organizational maintenance requirements for O-1A, O-1E, OV-1A, OV-1B, OV-1C, U-1A, U-6A, U-8D, U-8F, CH-21C, CH-34A, CH-34C, CH-37A, CH-37B, CH-47A, UH-1B, UH-1D, UH-19C and UH-19D aircrafts.

* U . S . GOVERNMENT PRINTING OFFICE : 1991 0 - 281-486 (42592)

